

# On Optimal Control for Concept Evaluation and System Development in Construction Machines

BOBBIE FRANK

FACULTY OF ENGINEERING | LUND UNIVERSITY

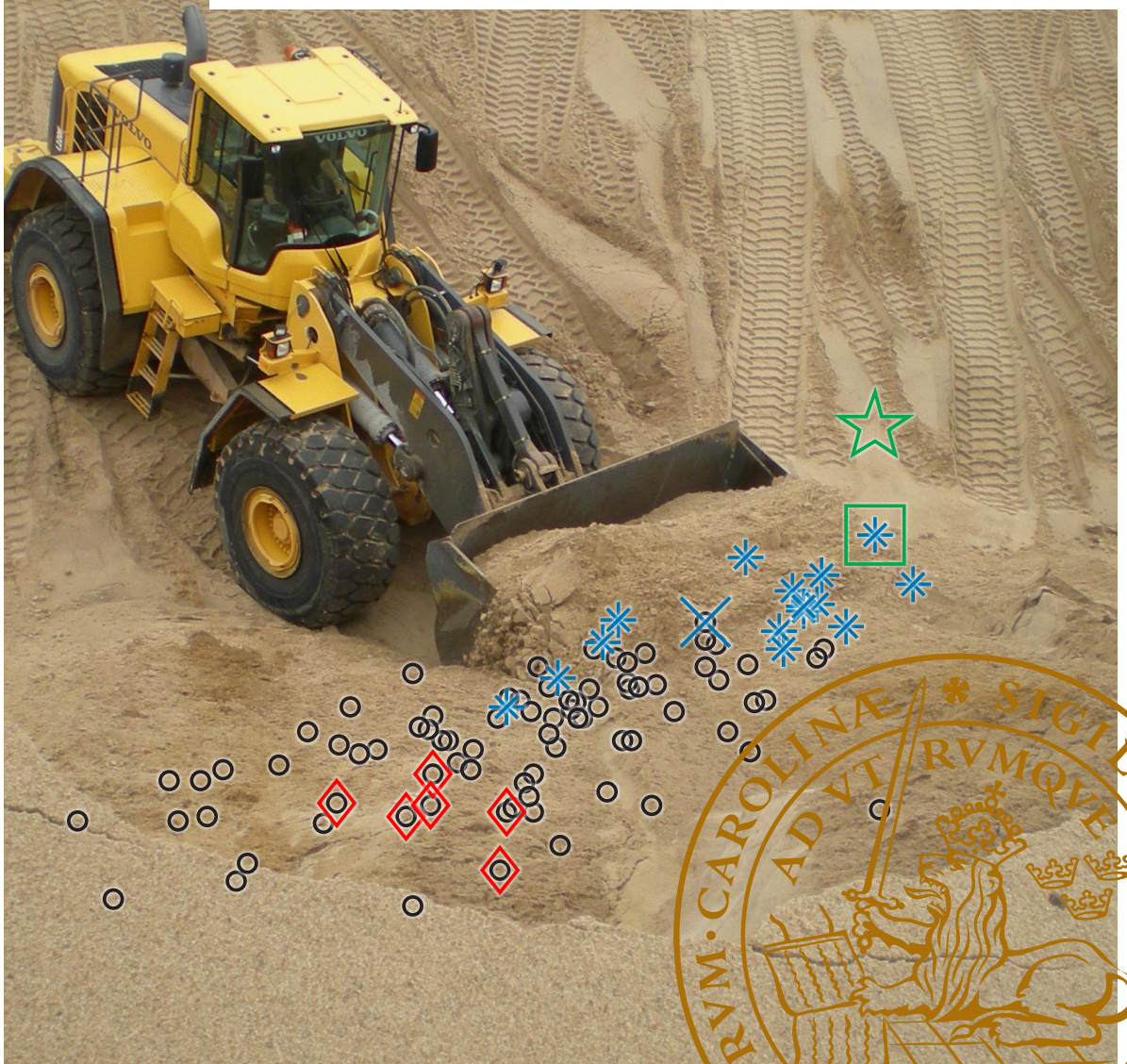



Bobbie Frank has a M.Sc. degree in Engineering Physics from the Faculty of Engineering at Lund University in Sweden. He has been working for Volvo Construction Equipment since 2007. The majority of the work has been carried out within modeling, simulation, new machine concept evaluation, complete machine system design, component design, complete machine control, subsystem control, operator behavior and customer understanding. He has been a part time industrial Ph.D. student since 2008. The first three years at Fluid and Mechatronic Systems, Linköping University, and the remaining years at Industrial Electrical Engineering and Automation, Lund University.



**LUND**  
UNIVERSITY

Faculty of Engineering  
Department of Biomedical Engineering  
Division of Industrial Electrical Engineering and Automation

ISBN 978-91-88934-91-8



# On Optimal Control for Concept Evaluation and System Development in Construction Machines

Bobbie Frank



LUND UNIVERSITY

Akademisk avhandling som för avläggande av teknologie doktorsexamen vid tekniska fakulteten vid Lunds Universitet kommer att offentligens försvaras fredagen den 7e september, 2018, kl. 11.15 i sal M:B, M-huset, Ole Römers väg 1, Lund.

Handledare för avhandlingen: Professor Mats Alaküla, Dr. Francisco J. Marquez-Fernandez.  
Fakultetsopponent: Dr. Giorgio Rizzoni, Professor of Mechanical and Aerospace Engineering and of Electrical and Computer Engineering at The Ohio State University, Columbus, USA.

Academic thesis which, by due permission of the Faculty of Engineering at Lund University, will be publicly defended on Friday 7<sup>th</sup> of September, 2018, at 11.15 in lecture hall M:B, M-building, Ole Römers väg 1, Lund, for the degree of Doctor of Philosophy in Engineering.  
Thesis supervisors: Professor Mats Alaküla, Dr. Francisco J. Marquez-Fernandez.  
Faculty opponent: Dr. Giorgio Rizzoni, Professor of Mechanical and Aerospace Engineering and of Electrical and Computer Engineering at The Ohio State University, Columbus, USA.

Organization: <b>LUND UNIVERSITY</b> Faculty of Engineering Department of Biomedical Engineering Division of Industrial Electrical Engineering and Automation	Document name: <b>DOCTORAL DISSERTATION</b>	
	Date of defense: 2018 September 07	
Author: Bobbie Frank	Sponsoring organizations: Volvo Construction Equipment Energimyndigheten (Swedish Energy Agency) VINNOVA (Sweden's Innovation Agency)	
	Title: On Optimal Control for Concept Evaluation and System Development in Construction Machines.	
Abstract: <p>The main goal with this thesis is to develop a method to maximize the fuel efficiency [ton/l] in construction machines, while fulfilling the desired productivity [ton/h]. This is achieved by focusing on two of the main influencers; the machine concept evaluation and the development of operator assist systems. To be able to perform a concept evaluation, and the necessary system optimization, that is unbiased from control engineering experience and test repetitiveness, an optimal control algorithm based on dynamic programming, which ensures global optimum, is developed. The optimal control results from the concept evaluation are able to provide input when developing control strategies for operator assist systems, automatic functions and autonomous machine control.</p> <p>The method is demonstrated on a wheel loader, working in a production chain, but can be applied to other construction machines, for example articulated haulers and excavators. Common denominators can be found with forestry equipment, agriculture machines and on-road vehicles. The optimal control algorithm is put to test by challenging the calculated theoretical optimum with measured data from an extensive empirical study to test the validity of the global optimum found.</p> <p>The main result is that the optimal control algorithm, based on dynamic programming, successfully works. The result demonstrates approximately 14% better energy efficiency in a gravel application, compared to the most fuel efficient operator's best work cycle in the empirical study. The best measured work cycle is approximately 30% better than the average in the study. A similar result is shown in a timber grapple application.</p> <p>The proposed method, and the algorithm developed, work for all three investigated machine concepts demonstrated. The results from the concept comparison example indicate that the parallel hybrid has about 5% higher fuel efficiency and the series hybrid wheel loader has around 23% higher fuel efficiency compared to the conventional machine, which is used as baseline, at the same productivity. In an example of a system optimization for the primary energy converter, the genset, internal combustion engine and electrical machine, in the series hybrid wheel loader indicate that the optimal power rating of the genset in the investigated application is 0.6 times the internal combustion engine power rating of the conventional wheel loader, resulting in approximately 6% higher fuel efficiency at the same productivity.</p> <p>With the proposed method it is shown how to extract input to the development of operator assist systems, automatic functions, and autonomous construction machine control development from the optimal control results. The results are attained from the optimal control calculations performed in early development in the concept evaluation and system optimization. This also implies that the optimal control results, if used in the development of these advanced functions can increase the average fuel efficiency by up to 35-45%. The percentage is dependent on the operator's proficiency and application according to the conclusions from the empirical study.</p>		
Key words: Construction Machines, Wheel Loader, Fuel Efficiency, Productivity, Operator Behavior, Optimal Control, Dynamic Programming, Complete Work Cycle, Actuator Movement Optimization, Bucket Fill Trajectory, Gravel Simulation, Concept Evaluation, System Optimization, Operator Assist Systems, Automatic Functions, Autonomous Machines.		
Classification system and/or index terms (if any):		Language: English
Supplementary bibliographical information:		ISBN: 978-91-88934-91-8 (print) 978-91-88934-90-1 (.pdf)
ISSN and key title:		
Recipient's notes:	Number of pages: 134	Price:
	Security classification:	

Distribution by IEA, Box 118, SE-22100 LUND, SWEDEN

I, the undersigned, being the copyright owner of the abstract of the above-mentioned dissertation, hereby grant to all reference sources permission to publish and disseminate the abstract of the above-mentioned dissertation.

Signature



Date

2018 May 17

# **On Optimal Control for Concept Evaluation and System Development in Construction Machines**

**Bobbie Frank**



**LUND UNIVERSITY**

**Thesis for the Degree of Doctor of Philosophy  
Division of Industrial Electrical Engineering and Automation  
Department of Biomedical Engineering  
Faculty of Engineering**

**2018**

*Cover illustration front:*

Volvo L220F wheel loader working as a part of a production chain, extracting natural sand from virgin bank. The photo is taken by the author at a customer site in Sweden, in the summer of 2010. Overlaid data points from Fig. 6.2.

*Cover illustration back:*

Author's portrait.

Division of Industrial Electrical Engineering and Automation  
Department of Biomedical Engineering  
Faculty of Engineering  
Lund University  
Box 118  
221 00 LUND  
SWEDEN

<http://www.iea.lth.se>

ISBN: 978-91-88934-91-8 (print)

ISBN: 978-91-88934-90-1 (.pdf)

CODEN: LUTEDX/(TEIE-1088)/1-134/(2018)

© Bobbie Frank, 2018

Printed in Sweden by Media-Tryck, Lund University.  
Lund 2018

*Mamma,  
Du gav mig mitt liv,  
du gav oss ditt liv,  
du betalade med ditt liv.  
Jag hade aldrig varit här utan dig.  
Saknaden kommer aldrig försvinna.*

*“Stay calm, cool and collected,  
and all things will fall into place”  
- Old Chinese saying*

*“If everything seems under control,  
you're not going fast enough.”  
- Mario Andretti*





# Popular Summary

The main goal with this thesis is to develop a method to maximize the fuel efficiency [ton/l] in construction machines, while fulfilling the desired productivity [ton/h]. This is achieved by focusing on two of the main influencers; the machine concept evaluation and the development of operator assist systems. To be able to perform a concept evaluation that is unbiased from control engineering experience and test repetitiveness, an optimal control algorithm based on dynamic programming, which ensures global optimum, is developed. This algorithm is also able to handle the system optimization that is a necessity when performing a machine concept evaluation. The optimal control results from the concept evaluation are able to provide input when developing control strategies for operator assist systems, automatic functions and autonomous machine control.

The method is demonstrated on a wheel loader, working in a production chain, but can be applied to other construction machines, for example articulated haulers and excavators. Common denominators can be found with forestry equipment, agriculture machines and on-road vehicles. The optimal control algorithm is put to test by challenging the calculated theoretical optimum with measured data from an extensive empirical study to test the validity of the global optimum found.

The optimal control algorithm, based on dynamic programming, successfully works. The result demonstrates approximately 14% better fuel efficiency in a gravel application, compared to the most fuel efficient operator's best work cycle in the empirical study. The best measured work cycle is approximately 30% better than the average in the study. A similar result is shown in a timber grapple application.

The proposed method, and the algorithm developed, works for all three investigated machine concepts, enabling an unbiased concept evaluation and system optimization. The method is demonstrated on a concept comparison between a conventional wheel loader, a parallel hybrid wheel

loader and a series hybrid wheel loader. The results from the concept comparison example indicate that the parallel hybrid has about 5% higher fuel efficiency and the series hybrid wheel loader has around 23% higher fuel efficiency compared to the conventional machine, which is used as baseline, at the same productivity. In an example of a system optimization for the primary energy converter, the genset, internal combustion engine and electrical machine, in the series hybrid wheel loader indicate that the optimal power rating of the genset in the investigated application is 0.6 times the internal combustion engine power rating of the conventional wheel loader. Even if the factor 0.5 showed even higher fuel efficiency, that power rating is not allowed due to complete machine performance requirements. The difference between the largest genset power rating, which is equivalent to the power rating of the conventional wheel loader, and the optimal, is approximately 6% higher fuel efficiency at the same productivity.

With the proposed method it is shown how to extract input to the development of operator assist systems, automatic functions, and autonomous construction machine control development from the optimal control results. The results are attained from the optimal control calculations performed in early development in the concept evaluation and system optimization. This also implies that the optimal control results, if used in the development of these advanced functions can increase the average fuel efficiency by up to 35-45%. The percentage is dependent on the operator's proficiency and application according to the conclusions from the empirical study. A suggestion of how to use the optimal control results as input, when developing operator assist systems, automatic functions and autonomous machine control, is also presented.

# Populärvetenskaplig Sammanfattning

Huvudmålet med denna avhandling är att utveckla en metod för att maximera bränsleeffektiviteten [ton/l] i anläggningsmaskiner, samtidigt skall föreskriven produktivitet [ton/h] bibehållas. Detta genomförs genom att fokusera på två av de faktorerna som influerar bränsleeffektiviteten mest: maskinkonceptutvärderingen samt utvecklingen av förarstödsystem. För att kunna utföra konceptutvärderingar som är opartiska, gällande reglerteknikingenjörskompetens och testrepeterbarhet, utvecklas en optimalstyrningsalgoritm baserad på dynamisk programmering. Denna algoritm kan även utföra systemoptimering, vilket är en nödvändighet vid utförandet av en konceptutvärdering. Resultaten från optimalstyrningen i konceptutvärderingen används sedan som indata till utvecklingen av reglerstrategier i förarstödsystem, automatiska funktioner samt autonoma maskiner.

Metoden demonstreras på en hjullastare, som är del av en produktionskedja, men kan likväl appliceras på andra anläggningsmaskiner, t.ex. dumprar eller grävmaskiner. Gemensamma nämnare kan även hittas i exempelvis skogsmaskiner, jordbruksmaskiner samt vägfordon. Optimalstyrningsalgoritmen sätts på prov genom att utmana det beräknade teoretiska globala optimumet med mätdata från en omfattande empirisk studie. Detta för att testa giltigheten hos det funna globala optimumet.

Optimalstyrningsalgoritmen fungerar väl, resultaten visar på cirka 14% högre energieffektivitet i en grusapplikation jämfört med den mest bränsleeffektiva förarens bästa arbetscykel i den empiriska studien. Den bästa uppmätta arbetscykeln är cirka 30% bättre än medelvärdet i studien. Likvärdiga resultat kan ses i en timmergripapplikation.

Den föreslagna metoden, och den utvecklade algoritmen, fungerar för alla de tre maskinkoncept, konventionell hjullastare, parallellhybrid-

hjullastare samt seriehybridhjullastare, som ingår i konceptutvärderingen vilken metoden och algoritm demonstrerats på. Detta möjliggör en opartisk konceptutvärdering och systemoptimering. En konceptjämförelse är utförd mellan den konventionella hjullastaren, parallellhybridhjullastaren och seriehybridhjullastaren. Resultaten från jämförelsen indikerar att parallellhybriden har ungefär 5% högre bränsleeffektivitet och seriehybridhjullastaren cirka 23% högre bränsleeffektivitet, vid samma produktivitet, jämfört med den konventionella hjullastaren, vilken agerar som bas i jämförelsen. I ett exempel på systemoptimering av den primära energiomvandlaren, elaggregatet, d.v.s. den interna förbränningsmotorn och elmaskinen, i seriehybridhjullastaren indikeras att den optimala märkeffekten på elaggregatet i den studerade applikationen är 0,6 gånger märkeffekten på den interna förbränningsmotorn på den konventionella hjullastaren. Även om faktorn 0,5 visade på högre bränsleeffektivitet så är den märkeffekten inte tillåten på grund av prestandakrav på komplett maskin. Den optimala märkeffekten visar cirka 6% högre bränsleeffektivitet, vid samma produktivitet, än den högsta undersökta, vilken är ekvivalent till märkeffekten på den interna förbränningsmotorn.

Med den föreslagna metoden påvisas möjligheten att extrahera indata från optimalstyrningsresultaten till utvecklingen av förarstödsystem, automatiska funktioner samt reglering av autonoma maskiner. Resultaten kommer från konceptutvärderingen och systemoptimeringen gjord i tidiga faser av utvecklingen. Detta indikerar även att om optimalstyrningsresultaten används i utvecklingen av dessa avancerade funktioner, kan bränsleeffektiviteten höjas med upp till 30-45%. Procentsatsen är beroende på operatörens skicklighet och applikationen enligt slutsatser från den empiriska studien. Det presenteras även ett förslag på hur den extraherade indatan, från optimalstyrningsresultaten, kan användas inom utvecklingen av reglerstrategier i förarstödsystem, automatiska funktioner samt autonoma maskiner.

# Acknowledgements

Sitting a Sunday evening past midnight and reflecting over the people that I have around me, and have had during the past decade I'm feeling extremely lucky. I'm thinking that probably not that many people in the world have the fortune to be able to surround themselves with that many good people. I'm proud to be able to call all of you my friends!

When perusing a goal for almost a decade it's bound to be a large crowd of people that have helped out in one or another way. To all of you, and you know who you are - Thank You! With the risk in mind of unintentionally forgetting someone, I still want to mention a few that have had some kind of major impact, in general and/or in this specific project.

I want to start off by thanking Volvo Construction Equipment in Eskilstuna and my managers through the years, Lennarth Zander, Jenny Elfsberg, Andreas Nordstrand and Michael Stec, for having the patience and letting me pursue the PhD degree during all these years. Further on I want to thank Jan-Ove Palmberg for believing in me when starting my PhD, and Fluid and Mechatronic Systems, Linköping University, for taking me in and helping me getting started. I want to express my deepest gratitude to Mats Alaküla who has been standing by my side relentlessly in ups and downs for over a decade, starting off with the master thesis in 2007. Also thank to Industrial Electrical Engineering and Automation, Lund University, and all the people there; it's not to take for granted that you can pop by once or twice a year and still feeling like you were there every other day. Especially thanks to Carina Lindström for arranging with all the administration and Francisco Marquez-Fernandez for taking on the supervisor roll and supporting me. I also want to thank my supervisors and project managers at Volvo, Anders Fröberg and Jonas Larsson, not only for taking care of the administrative work but also for your guidance and the interest both of you have shown for my work.

Getting the help from Jan Kleinert and Martin Obermayr, at Fraunhofer ITWM in Kaiserslautern with the gravel pile simulations was a milestone in the project to ensure results as close to reality as possible, thank you guys. The same goes for Vehicular Systems, Linköping University, which helped me out with the development of the pattern recognition algorithm.

At every major crossroad in life a new road is about to be traveled. Once you have entered that road, that you actually don't know anything about, it helps tremendously to have the support of experienced, informal mentors that willingly guide you on this new path in life. Reno Filla and Joakim Unnebäck, thank you for being those mentors and for introducing me to the construction industry. I also want to thank Lennart Skogh, the man who never backs down from a challenge and that helped me to do the measurements in the empirical study when no one else believed that it actually could be done.

When moving away from family and friends it is important to restore the order and get an additional family that you can trust and that supports you when you are away from home. Johan Hallman, Robert Morelius, Kenneth Svalelid, Kim Heybroek, Vilhelm Fredriksson and Daniel Krainer, thank you for being that family. Especially I would like to thank Kim for not only making me a better researcher but also a better person by always asking "Why?" and never settle until every detail is meticulously investigated. I also want to say an extra thank you to Johan and Robert for all the effort you have put into reviewing and revising the thesis, different papers and other miscellaneous projects over the years.

Last, but absolutely not least, I want to thank my caring and loving family for always standing by my side and supporting me in all different ways possible. My father who supported the first tough years at the university, the most kind-hearted little brother you can wish for and the most important of all – my mother, who is the reason for why I'm writing this. Without her tireless encouragement, support and forcing me to school when I was young I wouldn't be writing this today. Thank you for everything mamma, I wish you were here sharing the end result with me...

Eskilstuna, May 2018

*Bobbie Frank*

# Contents

<b>CHAPTER 1 INTRODUCTION.....</b>	<b>1</b>
1.1 BACKGROUND - WHEEL LOADERS .....	4
1.2 WHEEL LOADER OPERATION OPTIMIZATION .....	14
1.3 GOAL .....	19
1.4 METHOD .....	20
1.5 CONTRIBUTIONS .....	21
1.6 PUBLICATIONS .....	22
1.7 THESIS OUTLINE .....	26
<b>CHAPTER 2 EMPIRICAL OPTIMUM STUDY.....</b>	<b>29</b>
2.1 MEASUREMENT SETUP .....	31
2.2 DATA ANALYSIS .....	34
2.3 OPERATOR TRAINING TOOL .....	47
2.4 EMPIRICAL STUDY OUTPUT.....	52
<b>CHAPTER 3 THEORETICAL GLOBAL OPTIMUM – MODELING AND OPTIMAL CONTROL METHOD.....</b>	<b>55</b>
3.1 SYSTEM SETUP.....	55
3.2 PROBLEM FORMULATION .....	57
3.3 OPTIMAL CONTROL METHOD.....	58
3.4 DYNAMIC PROGRAMMING IMPLEMENTATION.....	60
3.5 SIMULATION MODEL .....	63
3.6 TRAJECTORY GENERATION .....	72
3.7 HOLISTIC MODEL OVERVIEW .....	74
<b>CHAPTER 4 COMPARISON ANALYSIS.....</b>	<b>79</b>
4.1 GRAVEL APPLICATION.....	83
4.2 TIMBER APPLICATION.....	87

4.3 SIMPLE PERFORMANCE INDICATORS VS. OPTIMAL CONTROL ..... 90

**CHAPTER 5 CONCEPT EVALUATION AND SYSTEM OPTIMIZATION..... 93**

5.1 CONCEPT EVALUATION SYSTEM SETUP ..... 95

5.2 RESULTS ..... 100

**CHAPTER 6 OPERATOR ASSIST, AUTOMATIC FUNCTIONS AND AUTONOMOUS MACHINE CONTROL DEVELOPMENT INPUT ..... 107**

6.1 AUTOMATION LEVELS ..... 108

6.2 OPTIMAL CONTROL INPUT ..... 110

6.3 OPERATORS VS. OPTIMAL CONTROL ..... 111

6.4 RESULTS ..... 115

**CHAPTER 7 DISCUSSION AND FUTURE WORK ..... 119**

**CHAPTER 8 CONCLUSIONS..... 123**

**REFERENCES..... 127**



# Chapter 1

## Introduction

Customers that buy construction machines use them as tools to generate income. In order to maximize their profits, it is essential to minimize the running costs, e.g. fuel, maintenance, repairs and operator wage. Taking profitability and low environmental impact into consideration, it is extremely important to optimize the fuel efficiency [ton/l] and productivity [ton/h] of each construction machine. Three of the main influencers are: the complete machine concept, the site environment and the operator controlling it.

To be able to base the machine concept evaluation and system optimization as well as the development of operator support systems, such as: assist systems, automatic functions and autonomous machine control, on using the same algorithms and modeling methods is a great benefit regarding development cost and time. It is important to find a global optimum to rule out any uncertainties during development and decision taking. This is simplified by using optimal control, e.g. the method “dynamic programming”.

Evaluation of new construction machine concepts is usually done through simulation or calculation as a first step in the research and development process. Simulations of alternative machine concepts are often based on measurements made on conventional machines including its functional constraints. Rough control strategies used in concept evaluation are typically developed by a simulation engineer, not necessarily having solid control engineering background. This may lead to a biased comparison of different concepts due to the influence of non-optimal control, i.e. possibly erroneous conclusions. Once built, the

fuel efficiency and productivity comparison between machine concepts becomes even more complicated. In measurements the uncertainty of the control strategies is still present, the machine concept and a possibly poor control strategy is evaluated instead of only the machine concept itself. In addition the test repeatability is introduced as well, resulting in that to get accurate fuel efficiency and productivity increase potential the test engineer has to perform a series of measurement. A measurement like this can be ongoing for several weeks.

If the machine concept to be evaluated is similar to a conventional one with regard to how the machine harmony properties [1] are set, that is how the driveline and working hydraulics work together to actuate the bucket through the lifting unit, are defined by hydraulic and mechanical components, e.g. hydraulic pump power rating and torque converter stiffness, the classical system optimization approach might work. However, when e.g. a full series diesel-electric hybrid wheel loader is to be evaluated, where all the components are fully decoupled, with the additional degrees of freedom that follows, the machine harmony properties of the wheel loader are to a larger extent set in the control algorithms. This can result in the situation that the, often “quick and dirty”, rough control algorithms used in the beginning of development affects the results in a too large extent when performing concept evaluations with regard to fuel efficiency and productivity. If the analysis is performed based on measurement data from a conventional wheel loader the results are distorted even further. This is due to the fact that full series hybrids, with electrical machines close to every actuator, are likely to have different operational “sweet spots” with regard to fuel efficiency compared to the conventional hydraulic-mechanical system. Using optimal control enables to perform concept evaluation and system optimization on new machine concepts with large differences from the conventional machine, such as a series hybrid wheel loader. Thus the optimization results are unbiased from simulation and control engineer experience as well as test repeatability.

Due to the high potential in reducing the total cost of ownership the transition towards autonomy, via automatic functions and operator assist systems, in working machines is ongoing and inevitable [2,3,4]. While there are many challenges left to solve in the automation of working machines [5], solutions, often based on engineering expertise and experienced test operator input, can be found in literature [6]. Much effort

is put on automatic functions [7] and human-machine interface [8]. As fossil fuel consumption reduction and lower environmental impact continues to gain importance, for both customers and manufacturers of construction equipment, it becomes more critical to also have fuel efficient algorithms in operator assist systems, automatic functions and autonomous machines, and not only have a fuel efficient standard machine. To be able to develop robust algorithms for these functions in different applications and weather conditions, with regard to fuel efficiency and productivity, the knowledge base of the engineers and the amounts of tests gets large and hard to handle. One way of solving this is to perform virtual testing and develop these functions by utilizing optimal control.

Performing the optimization early in the development, during the concept evaluation and system optimization phase [9], the results are already in place and can be considered “for free” for subsequent development steps. The results from the optimal control calculations can then be implemented in low-cost and easy-to-install control algorithms, such as rule-based algorithms as an example, that are more suitable for real time applications [10]. In [11,12] dynamic programming is used for sizing of the energy storage, however the method presented in this thesis extends substantially this scope, including the size of the most relevant components in all major subsystems in the complete machine. The solution can then be tested virtually, and by using the proposed method, the development of operator assist systems, automatic functions and autonomous machine control can be performed in shorter development time, consequently with a significant development cost reduction. The impact of inconsistent operator behavior [13] and problems with test repeatability are also minimized. The optimal control results are compared with measurement data from an extensive empirical study to ensure validity.

The methodology presented in this thesis is showcased at a complete machine level on a larger wheel loader that works in a production chain. The choice of machine is due to the hard coupling, visible in Fig. 1.5, which inherently exists in a wheel loader between the driveline, the hydraulic system and the combustion engine. The methodology can just as well be used during the development of other construction machines, such as articulated haulers and excavators where the main power flow is either to the hydraulics or the traction – not split like in the wheel loader. The method presented can also be applied in other industries that are facing

similar challenges when evaluating new machine concepts and/or developing operator assist functions. Industries can be, but are not limited to, agriculture and forestry, where the machine topology with parallel power flows, material interaction and that the machine performance limitations are set by the operator, are present. An example is found in [14,15], where dynamic programming is used in energy optimizing the hydraulic system in forestry equipment. On-road vehicles can benefit from using the proposed method as well but not as significantly due to the single power flow path.

## **1.1 Background - Wheel Loaders**

As described in [1,32], the wheel loader is a versatile working machine used in a vast variety of applications with different attachments such as bucket [13], grapple [16], material handling arm, etc.. The focus in this thesis is on wheel loaders that are part of a production chain, in particular bucket applications. One common task is loading material from the face of a material pile or a virgin bank, where materials can include blasted rock, clay or natural sand. Another traditional task is rehandling, where the wheel loader handles pre-processed material, after a crusher, to feed the next part in the production chain, e.g. building stockpiles or loading out-going trucks from the site. Since there are many different applications for the wheel loader, it is logical that their work cycles are different. The most common work cycles for production chain wheel loaders in bucket applications are the “short loading cycle”, also called “V-cycle” or “Y-cycle” in literature [17,18], and the “load and carry cycle”. The major differences between the two cycles are the transport distance, the initial velocity into the gravel pile and that the need for using all actuators at the same time is more critical in the “short loading cycle” [1]. A visualization of a “short loading cycle”, loading blasted rock onto an articulated hauler from face as a part of a production chain, is shown in Fig. 1.1.



Fig. 1.1 A wheel loader performs a "short loading cycle" in blasted rock from face as a part of a production chain. Modified from [19].

A couple of hundred thousand wheel loaders are sold all over the world each year. Typically, wheel loaders are sold as multi-purpose machines, equipped with quick attachment bracket to handle multiple attachments, or production machines. These production machines, which represent approximately half of all machines sold, are part of a larger production chain, specialized in one particular task, often some sort of bucket application in, for example, an open pit mine or quarry. This means that uptime, productivity, fuel efficiency and operability are key features [20] to be able to solve the specific work assignment as quick as possible to the lowest possible cost per ton loaded material. The fuel cost represents approximately 30-60% of the total cost of ownership, in cost per ton loaded material, depending on the geographical market, see Fig. 1.2.

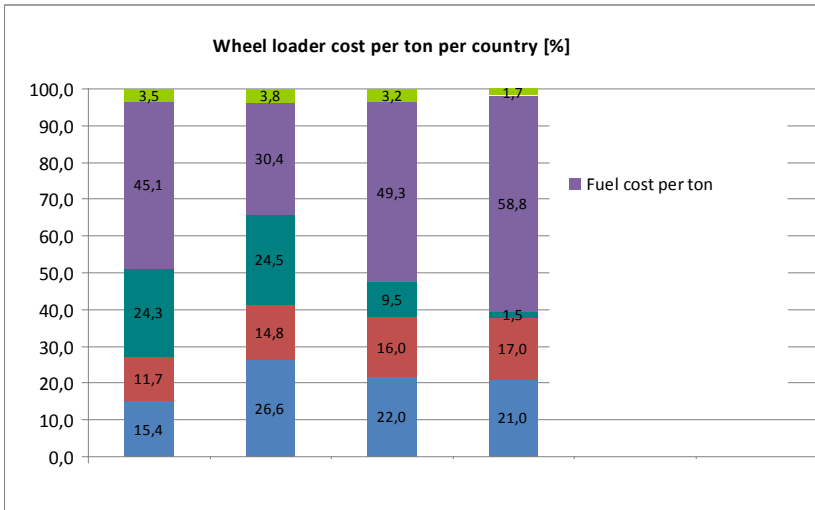

Fig. 1.2 Estimated fuel cost per ton for a larger wheel loader that are working in a bucket application in a production chain [21]. One country per region serves as an example and all other costs are hidden due to intellectual properties.

Fig. 1.2 shows that fuel efficiency [ton/l] is an important aspect when purchasing a wheel loader. However, not shown in this chart is that productivity [ton/h] is equally, or even more, important. If the production rate cannot be maintained then the total production at the site might slow down, resulting in extensive loss of income.

To maximize income, minimizing the running costs is essential. Taking this aspect and environmental care into consideration, it is important to optimize the fuel efficiency [ton/l] and productivity [ton/h] of each construction machine and the complete site.

The fuel efficiency and productivity of a production machine, using the wheel loader in a bucket application as an example, mainly depend on the *machine specification*, the *working environment* and the *operator behavior*.

- The fuel efficiency and productivity due to the *machine specification* can be affected in three main ways:
  - Using the correct wheel loader size [22]. This is specified by the customer, however the dealer can assist, using advanced software

to simulate the customer site [23]. It is vital to identify a machine of the right capacity to be able to keep the productivity and to solve the specified work assignment. For instance an undersized machine is not suitable for loading shot rock from face. It is however equally important to not use an over-sized machine, since a too large wheel loader perform at a lower efficiency for the same work task due to part load operation of major components. A too large wheel loader is also not fully utilized, which ties up capital unnecessarily.

- The equipment and attachment of the wheel loader, such as e.g. the tires and the type of bucket. This is usually specified by the customer but the dealer can help in the same way as with machine sizing, depending on the application and primary work assignment of the wheel loader [22,23].
- The base machine efficiency, meaning the efficiency of the wheel loader itself, which is the result of the efficiencies of all the components of the wheel loader and the way they are controlled. Everything from the engine to the transmission to the hydraulic system and, of course, also the complete machine control system is taken into consideration. This also comprises the machine concept, which can include, but is not limited to: hydrostatic or mechanical transmission, diesel electric hybrid, hydraulic hybrid or mechanical hybrid, all ranging from mild parallel hybrid to full series hybrid. Within all machines the major subsystems and components in the machine are also sized with regard to rated power [9]. The machine efficiency is something the machine manufacturers are striving to increase [24,25] because it is a major competitive advantage to have a wheel loader with high fuel efficiency and productivity.
- The *working environment*, the site layout and the planning of the site is also important to maximize fuel efficiency and productivity. For example: not to carry material longer than necessary and not to stock-pile unnecessarily. The properties of the loaded material, such as excavation severity and density [26], are included here as important parameters as well. The site planning is mostly done by the customer but sometimes the dealer [23] or an external consultancy company provide operator training [27] and/or supports in the initial planning of the site.

- The *operator behavior* is the single most important parameter once the machine, including the equipment and the attachment, is determined and the site is planned [28]. Throughout the working life of a wheel loader the operator is the main influencer on efficiency and productivity that, coupled with the assigned work task, affects the fuel efficiency and productivity the most. The traditional way to address the fuel efficiency and productivity difference due to operator behavior distribution is operator training such as the Eco Operator training or equivalent [29,30]. During operator training, a trainer coaches the operator during a number of days, providing theoretical and practical education to increase the fuel efficiency and productivity. A simpler alternative is to distribute manuals [31] from where the operators can get some tips on operating the wheel loader in a more efficient way. However, in the near future operator assist systems, automatic functions and semi- to full autonomous machines will be an alternative way to improve operator behavior and lower the dependency on the skill level of the operator [10].

To be able to explain the operator position in the control system and the power balance in the wheel loader throughout a work cycle, a typical “short loading cycle”, see Fig. 1.3, is explained first.



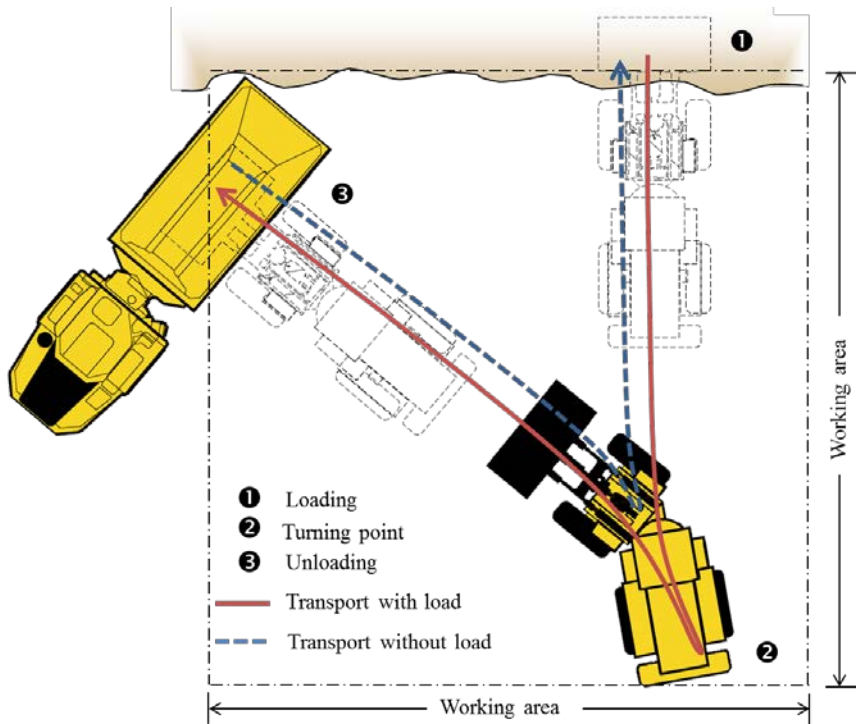

Fig. 1.3 Visualization of the “short loading cycle”, showing the phases and working area, modified from [1].

Assume that the wheel loader starts at the turning point, **2**, driving forward towards the pile and accelerating after just putting the machine into forward and decelerating just before the pile. Then entering the pile, at **1**, where the operator starts lifting gravel in the bucket, thus putting pressure on the front wheels in order to increase friction, and getting the traction needed to penetrate the pile further. While driving forward, the operator needs to balance the lifting and tilting of the bucket in order to complete the bucket fill phase successfully. After the bucket fill is completed the operator selects reverse gear and accelerates backwards, decelerating just before the turning point, **2**. Then the operator selects forward gear, accelerating to later on decelerate again just before the load receiver. During the complete traveling phase the operator has lifted the bucket to ensure the precise height is reached, so that the “Unloading” phase, at **3**, can begin. In the “Unloading” phase the operator is lifting

and tilting the bucket forward to dump the material in the correct place onto the load receiver. Transporting and lowering the bucket towards the pile is done in the same way as towards the load receiver but the other way around [32]. The interconnection between the height of the bucket and the position of the wheel loader can be illustrated in a so called “machine harmony diagram” [32], see Fig. 1.4. This helps to further understand the simultaneous operation that is required in a “short loading cycle”.

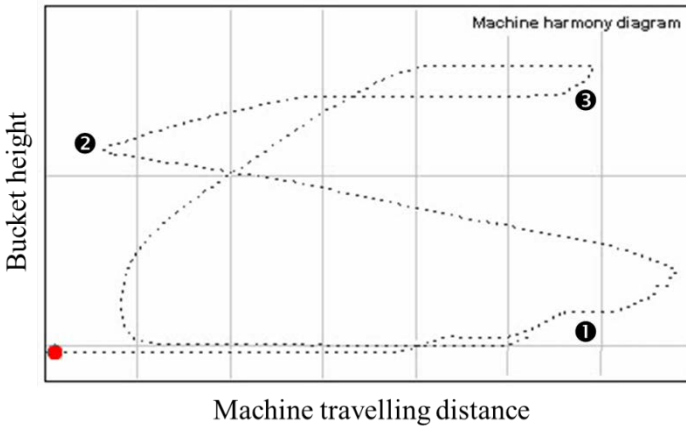

Fig. 1.4 Machine harmony diagram with the same identified phases as in Fig. 1.3, modified from [32].

Supported by Fig. 1.5, the control effort of the operator during the typical “short loading cycle”, with a conventional wheel loader, in Fig. 1.3 can be described as follows: *when approaching the pile* from the reversing point the operator has to not only transport the machine to the front of the pile but also position the machine in a way that the machine enters the pile at a good entry point. Both lateral and vertical position has to be taken into consideration when entering the gravel pile, depending on how the pile looks like but also the position of the bucket in relation to the ground so that the worksite is not destroyed. Once *in the bucket fill phase*, the operator has to start with enough penetration to be able to lift enough material. This is to ensure sufficient ground pressure to guarantee enough traction to secure the capability to penetrate the gravel pile and even more to be able to fill the bucket. The timing of lifting and tilting the bucket is important to avoid getting stuck while having continuous penetration through the pile, minimizing the loading time and maximizing the load in

the bucket. The operator is balancing traction during the complete bucket fill phase, which is nonlinear due to the converter characteristics and the working hydraulics, which also depends on the speed of the engine and the displacement of the hydraulic pump. When the hydraulic pump is used at maximum displacement, the tilt gets priority over the lift due to the lower pressure demand, resulting in reduced lift. To add further complexity the steering always has priority, meaning that the speed of the lift and tilt depends on how fast the operator steers. The working hydraulics has priority over the propulsion. This means that the accelerator pedal is not only controlling the traveling, with nonlinear traction torque, but also the speed of the hydraulic pumps, resulting in a dependence on the accelerator pedal position for the lift and tilt speed at a given position of the lift and tilt lever. The lift lever controls the lift speed, or force at e.g. stall, of the bucket but also the longitudinal position of the bucket because of the linkage layout. The tilt lever controls the angle speed, or force at e.g. stall, of the bucket but also indirectly the lift speed due to the priority. The only input the operator has is the viewing of the gravel pile and the speed of the different actuators, propulsion, lift, tilt and steering, see Fig. 1.5. While *reversing from the gravel pile*, changing to forward gear *and approaching the load receiver*, the operator has to ensure that the bucket has reached the correct height to be able to get over the edge of the load receiver and dump the material in the bed. Under the same restrictions as during bucket fill, the lift speed is dependent on the engine speed that is controlled by the accelerator pedal, which also controls the machine speed. This results in a delicate choice of turning point, ②, in Fig. 1.3, depending on machine layout. When returning to the gravel pile the bucket has to be positioned to start the bucket filling phase once again [1].

The operator in a wheel loader is very much in the center of the control loop, having a lot more inputs and outputs than a driver of an on-road vehicle, e.g. a long-haul truck, see Fig. 1.5. This, in turn, implies that the operator of a wheel loader, performing a specific work assignment, affects the fuel efficiency and productivity to a higher degree than a driver in an average on-road vehicle. In addition, the performance indicators of a wheel loader operator are two dimensional, fuel efficiency [ton/l] and productivity [ton/h], comparing to the on-road driver that only have to concern about the fuel consumption, [l/km] for passenger cars or [l/(ton·km)] for commercial vehicles – with a set velocity given by the legal speed limit. An even more important aspect is that when an operator cannot hold the required production rate a complete production chain can

slow down, resulting in large income losses. In both off-road and on-road applications the minimization of the wear of the machine or vehicle is an interesting parameter to consider; this is however out of the scope of this thesis. To include the wear in the optimization would be ideal but would demand very high computational effort and require advanced models of the wear of each component, hence a useful first step is to consider fuel efficiency and productivity.

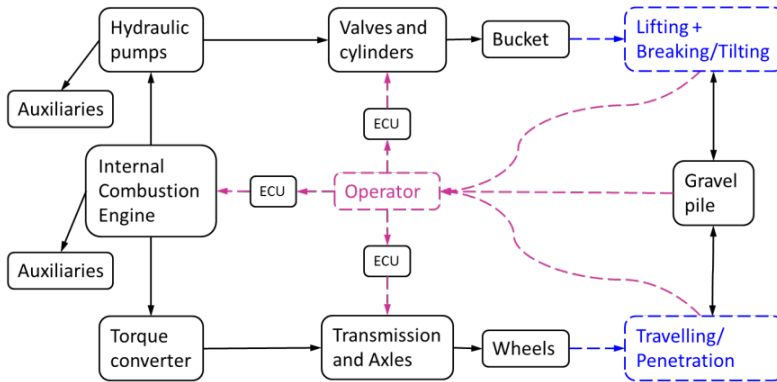

Fig. 1.5 A schematic diagram of the power balance and the control loop in a wheel loader during bucket fill [1,32]. ECU is an on-board computer.

The schematic diagram of the power flow in a wheel loader in Fig. 1.5, also reveals the complexity of the system. There is not only a coupling in the power flow from the combustion engine, which is coupled to the torque converter and the hydraulic pumps, but also at the bucket, where the wheels and cylinders are coupled via the gravel pile in the bucket fill phase. This means that the operator needs to balance the power available from the combustion engine between the two main power consumers: the driveline and the working hydraulics, at all times. Furthermore, the working hydraulics consists of two main functions, lift and tilt, and a number of support functions, such as steering and auxiliaries. A gravel pile model is necessary to get the correct coupling on the bucket-side in the schematic diagram in Fig. 1.5. This can be compared to the rolling resistance in an on-road application but it is responsible for almost all of the fuel consumed in the bucket fill phase, and approximately one third of the total amount of fuel consumed in a “short loading cycle” [33]. The importance to include an accurate gravel pile model cannot be emphasized enough.

Due to the complexity of the system, the difficulties and time consuming task to model the total system, including control algorithms, plant models and environment model - especially the gravel-bucket interaction - virtual concept evaluations and system optimizations have traditionally been done by simulation or calculation, often based on measurements of conventional wheel loaders. As stated before; this might work out fine for machine concepts not that different from conventional wheel loaders. However, when evaluating the fuel efficiency and/or productivity benefits of conventional vs. alternative wheel loader concepts, where the latter has decoupled software controlled actuators, this might result in sub-optimal solutions [34]. The reason for this is that the conventional machine and the alternative wheel loader concept become two different systems that are designed to solve the same task. In this case e.g. move a bucket of gravel or a load of timber from one place to another. The three major differences that make the traditional way of doing concept evaluations non-optimal in this case are:

- 1) There are *more degrees of freedom* in a machine concept with decoupled actuators compared to the conventional machine, resulting in a system that requires more work on the complete machine control algorithms. This has to be taken care of by a control software engineer in contrast to the conventional wheel loader where mechanical and hydraulic engineers tune components, like torque converter versus hydraulic machines, to ensure the desired machine harmony properties [1,32]. In addition, the fuel efficiency is much more dependent on the complete machine control algorithms than in a conventional wheel loader and the perceived fuel saving potential is often related to the control algorithm effectiveness. The same is valid for the productivity, which in many cases is just as, or even more, important for the end customer. This implies that the fuel efficiency and productivity outcome heavily depends on the experience and competence of the control engineer and the time invested into the control strategy development.
- 2) The two alternatives, the wheel loader with *decoupled actuators* and the conventional wheel loader, have different components closest to the actuators, resulting in different physical limitations, response times and, for fuel efficiency calculations, different efficiency characteristics. For these reasons, a good operating point in a

conventional machine can be non-optimal in another, new alternative, wheel loader concept.

- 3) The *operator influence*, which is known to affect the fuel efficiency and productivity to a large extent [13,35]. The operator is very much in the center of the control loop, see Fig. 1.5, and in the best case scenario he or she is able to adjust to different machine behaviors to get the most out of each machine. To force a different machine concept to be operated exactly the same way as a conventional wheel loader is unlikely to be an optimal control strategy. This is understood when studying the operator's position in the control loop when operating the wheel loader, especially in the bucket fill phase, see Fig. 1.5.

## 1.2 Wheel Loader Operation Optimization

As stated before, the wheel loader has more main actuators, propulsion, lift and tilt, when compared to a single propulsion actuator in e.g. a car, resulting in more degrees of freedom to optimize in the wheel loader case. In addition, the interaction with the environment in a car is limited to the interaction with the ground and air while in the wheel loader this interaction is more complicated. When filling the bucket all three actuators are working against a gravel pile in a complex power balance. As mentioned before, the operator is central in the control loop, see Fig. 1.5, meaning that different operator behaviors have a higher impact than in an on-road application.

In the literature, optimization of construction machines and wheel loaders in particular are studied. However, these studies only consider machine speed and lifting during the transport phase [53,76] or only focus on minimizing consumed fuel per travelled distance for the driveline [36], which is an oversimplification of the problem. In this thesis, a method for optimizing the complete work cycle, including the "Loading" phase with bucket fill in a verified simulated gravel pile, is presented. The "Loading" phase is important since approximately one third of the energy is spent in the bucket fill phase, where the gravel pile interaction is the major contributor [33]. The importance of the loading phase is recognized in literature such as [37] where simple performance indicators are used to study fuel efficiency improvement by optimizing bucket design and bucket filling. The bucket filling phase is also the most difficult part of the cycle for the operator. However in this thesis, in Chapter 4.3 it is demonstrated

that simple performance indicators are not enough but a complete work cycle optimization that ensures a global optimum is recommended to get an accurate result.

Optimal driving in on-road applications is amply covered in the literature such as [38,39,40,41,42,43], while similar problems are solved for off-road applications in [44,53,76] and the optimization of a full work cycle in a grapple application of a wheel loader is solved in [16]. In the literature, there is a tendency to simplify the models of the major components to suit the optimization tool chosen. If the problem is non-convex, and dynamic programming or an exhaustive search is not used, a global optimum cannot be guaranteed. This can be seen in e.g. [45] where component and control parameter optimization are addressed simultaneously, using a rule-based supervisory control strategy. In this thesis, a method is developed based on dynamic programming to ensure that the global optimum with regard to fuel efficiency and productivity is found. In [46,47,48,49] global optima are found to evaluate control strategies for the primary energy converter side, such as for example the internal combustion engine and/or hydraulic pumps, using dynamic programming, in off-road machines. This is to benchmark other control strategies for the primary energy converter that need less computational power but do not ensure a global optimum. The optimal control is however only performed on one subsystem in the machine, following a recorded load cycle, consequently global optimum is not guaranteed for the complete machine operation. The method presented in this thesis also takes the actuators, hence all the major subsystems in the machine, into consideration and does not rely on a recorded work cycle.

When discussing optimization of the wheel loader operation, regardless if it is targeting fuel efficiency [ton/l] or productivity [ton/h], what often comes into mind is to optimize the wheel loader itself and sometimes also the work cycle layout. However, the wheel loader operation optimization is not that simple – it is a part of a much larger system in a complete site, see Fig. 1.6 where different work tasks for a wheel loader in a quarry in a complete site perspective is visualized. This results in that to solve the complete optimization for a wheel loader is a problem too large to solve at once.

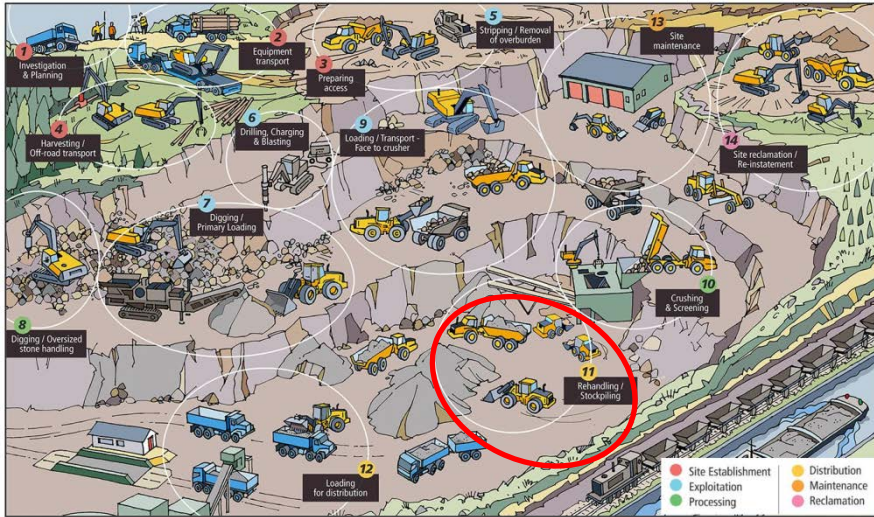

Fig. 1.6 Different work tasks for a wheel loader in a quarry in a complete site perspective [19].

A suggestion for subdividing the optimization into levels for a wheel loader, working as part of a production chain, is shown in Fig. 1.7. The example presented in this thesis is focusing on **11** – “Rehandling”, circled in red in Fig. 1.6, a wheel loader loading pre-processed material onto an articulated hauler in a “short loading cycle”.



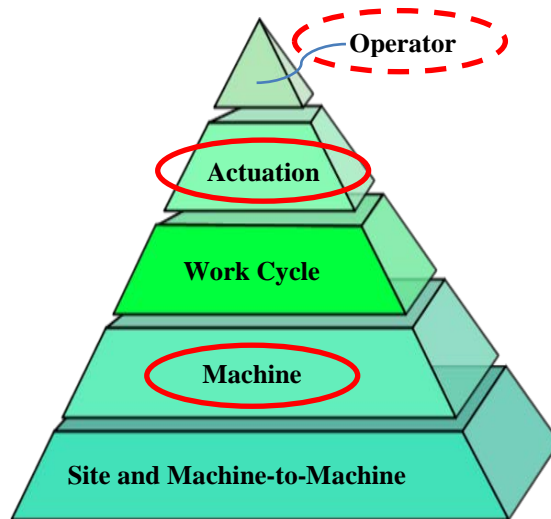

Fig. 1.7 Suggested optimization levels for a wheel loader, working as part of a production chain. Levels circled in red are targeted in this thesis [50].

The levels are defined as:

### **Site and Machine-to-Machine Optimization**

On a work site, for example a quarry or open pit mine, the fleet of machines and the layout of the site can be optimized with regard to energy usage for the complete site, production rate, initial costs, running costs of the site or a combination of them. This is a complicated task and it is often subjected to a complicated set of boundary conditions. For example, the contractor has a limited set of machines or the layout of the site has geographical constraints. Once a set of machines is chosen, a continuous optimization has to be done with regard to how the machines work together. Optimization at this level is not covered in this thesis but rather in literature such as [51,52].

### **Machine Optimization**

Given a work task, the wheel loader itself can be optimized, with respect to fuel efficiency and/or productivity. This includes different machine concepts, such as a conventional wheel loader, a diesel-electric hybrid wheel loader, a full electric wheel loader, etc. System optimization, which is the sizing of components such as internal combustion engine,

hydraulic pumps, lifting unit etc., is included as well. Both concept evaluation and system optimization is done by the wheel loader manufacturer. Using the method developed and presented a concept evaluation and a system optimization can be performed, see [9] and Chapter 5 for more details.

### Work Cycle Optimization

Given the machine and the work task, there is freedom in how to plan the work cycle. While some boundary conditions, such as gravel pile position and load receiver height are fixed, there are other boundary conditions that are flexible. These include: load receiver position, turning point of the wheel loader and the position trajectory between the gravel pile, turning point and load receiver. One result of the path planning optimization in [53,54] is shown in Fig. 1.8. Here the steer angle of the wheel loader together with the  $x$ - and  $y$ -positions are optimized. The lift is considered only to be able to determine that the required height at the load receiver is reached.

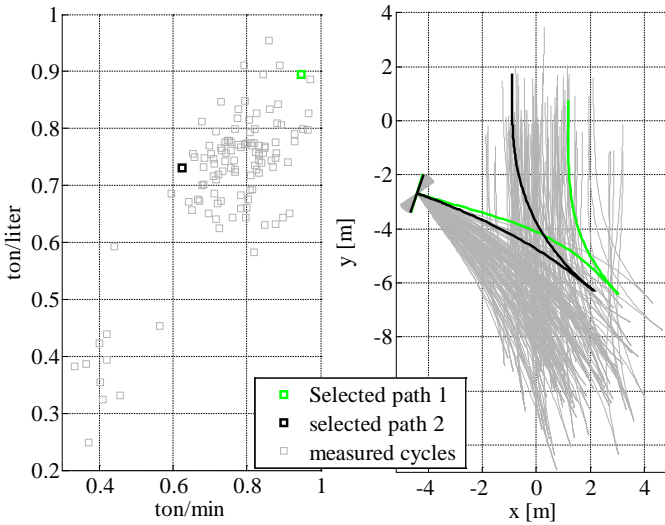

Fig. 1.8 Left: Normalized values for the recorded productivity from measurements. Right: Recorded Wheel Loader trajectories during measurements. The highlighted trajectories have almost the same traveling distance and bucket load, but are very different in productivity [53].

The path planning optimization of the work cycle is not covered in this thesis but rather in literature such as [53,54,55,56].

### **Actuation Optimization**

Given the work cycle path layout and the machine, the work cycle can be performed in different ways as regards actuation of the three main actuators: propulsion, lift and tilt. This results in different values of productivity [ton/h] and fuel efficiency [ton/l]. The method presented performs the actuator movement optimization by optimizing: the wheel loader velocity, lift position and tilt position in relation to covered distance by using dynamic programming. The main reason for splitting “Work Cycle Optimization” and “Actuation Optimization” is to get reasonable computation times.

### **Operator Optimization**

This is not really an optimization level if all other levels are optimized, but rather about how to influence the way the operator operates the machine. This can be done by operator support systems, automatic functions or autonomous machines control. Operator support systems can be, but are not limited to, operator training in a classroom, operator assist or guidance in the machine and semi-automatic functions. Even if the method presented here do not directly deliver such systems the results from the optimal control calculations can be used as input when developing them [10], hence the dashed circle in Fig. 1.7. More about operability in working machines in [1].

## **1.3 Goal**

The main objective in this thesis is to develop a method to maximize the fuel efficiency [ton/l] in construction machines, implemented in a wheel loader as an example, while fulfilling the desired productivity [ton/h]. This is done by targeting two of the main influencers: 1) the selection of the best complete machine concept, by performing an unbiased concept evaluation and system optimization, and 2) the development of operator assist systems and automatic functions.

To be able to perform a concept evaluation, that is unbiased from control engineering experience and test repetitiveness, an optimal control algorithm that ensures global optimum has to be developed. This algorithm also has to be able to handle the system optimization that are necessary to do when performing a machine concept evaluation.

The same optimal control results should be able to provide input when

developing real time control strategies for operator assist systems, automatic functions and autonomous machine control on any of the concepts in the concept evaluation.

The optimal control results should be put to test by challenging the solution with empirical data measurements to validate that the global optimum is found.

The method is demonstrated on a wheel loader, working in a production chain, but can as well be applied on other construction machines, for example articulated haulers and excavators. There could also be common denominators with forestry equipment, agriculture machines and to a minor extent also to on-road vehicles.

## 1.4 Method

To be able to meet the goals in Chapter 1.3, five work packages were set up according to:

- 1) *Perform operator deviation measurements.* This is an empirical study, where a larger set of operators are studied by performing physical measurements. This has two main objectives: first, to be able to challenge a theoretical global optimal solution with a measured empirical optimum and, second, to investigate the empirical potential with operator assist systems, automatic functions and autonomous machines.
- 2) *Calculate a theoretical global optimum,* with regard to fuel efficiency. This is necessary in order to find out the fuel efficiency potential for any given machine concept at a given productivity unbiased from parameters not influenced by the machine concept, such as control engineering experience and test repeatability. The optimal control method of choice is dynamic programming and the wheel loader is modeled with quasi-static power loss maps originating from test rig measurements. The optimization is done for a timber grapple application and a bucket application, loading gravel. The vehicle motion equation together with a Volvo internal kinematic model of the lifting unit is used outside of the gravel pile, while in the gravel pile a Discrete Element Method, DEM, gravel model is used to achieve as realistic results as possible.

- 3) *Perform a comparison analysis* where the optimal control results are compared to the results from the empirical study to ensure that the global optimum found is a realistic solution.
- 4) *A concept evaluation and system optimization* is performed to ensure that the method and algorithms developed can be used when evaluating new machine concepts. The results are compared to real measurements on a complete machine level to ensure reasonable results. A system optimization is also done to demonstrate the capabilities with regard to determine the power ratings of the major components in a wheel loader with regard to fuel efficiency with the desired productivity.
- 5) An analysis is performed on whether the results from the optimal control calculations can be used as *input when developing operator assist systems, automatic functions and autonomous machine control*.

## 1.5 Contributions

The *main outcome* of this thesis is a design methodology involving an optimization tool that can perform unbiased concept evaluation and system optimization in the beginning of research and development while simultaneously provide input to the development of operator assist systems, automatic functions and autonomous machine control in the final stages of the development for a given machine concept. The tool is provided in the form of a method on how to perform concept evaluation and system optimization of alternative machine concept in construction machines with parallel power flow paths. The tool is exemplified in a software package, based on the optimal control method dynamic programming, to be able to evaluate how the method performs in a realistic example.

The *main research contribution* in the optimization tool is to ensure successful actuator movement optimization, based on the optimal control method dynamic programming, in a *complete work cycle* with regard to fuel efficiency while fulfilling the desired productivity, including the three main actuators; propulsion, lift and tilt. This is accomplished with a proven environmental model, to guarantee correct interaction between the gravel pile and bucket, and with models of the wheel loader based on quasi-static maps of real test rig measurement data of all major components in the wheel loader. The result of the optimization, calculated in Chapter 3, is

then compared to the empirically best work cycle found in an operator deviation measurement study, presented in Chapter 2.

The research contribution in the concept evaluation and system optimization tool is that *the most fuel efficient way to operate any given wheel loader concept in a complete work cycle, at any given productivity within the machine specifications, can be calculated*. Using the proposed method, concept evaluations between new machine concepts and system optimization of any specific new machine concept, can be performed unbiased from control engineer experience and test engineer effort. This results in shorter development time and no need for control algorithm tuning for each concept. The impact of inconsistent operator behavior [13] and problems with test repeatability are also eliminated.

The research contribution, with regard to input to the development of operator assist systems, automatic functions and autonomous machine control, is *a method on how to be able to transfer results from the optimal control solution, calculated off-line with high computational effort in early research and development phases when investigating the machine concept, to advanced functionalities that needs to run in real time in a construction machine*.

## 1.6 Publications

The publications that this thesis is based on are listed below, I to XVI, together with a following Declaration of Contribution for each paper.

1<sup>st</sup> Author - Conference papers:

- I. Frank, B., Pohl, J., Palmberg, J-O., “Estimation of the Potential in Predictive Control in a Hybrid Wheel Loader”. 11<sup>th</sup> Scandinavian International Conference on Fluid Power (SICFP’09), Linköping, Sweden, June 2-4, 2009.
- II. Frank, B., Skogh, L., Alaküla, M., “On Wheel Loader Fuel Efficiency Difference due to Operator Behaviour Distribution”. 2<sup>nd</sup> Commercial Vehicle Technology Symposium (CVT 2012), Kaiserslautern, Germany, March 13-15, 2012. (*Endnote [13]*)
- III. Frank, B., Skogh, L., Filla, R., Alaküla, M., “On Increasing Fuel Efficiency by Operator Assistant Systems in a Wheel Loader”. 2012 International Conference on Advanced Vehicle Technologies and Integration (VTI 2012), China Machine Press, ISBN: 978-7-111-39909-4 or 978-7-89433-726-9, pp. 155-161, Changchun, China, July 16-19, 2012. (*Endnote*

[35])

- IV. Frank, B., Fröberg, A., “Establishing an Optimal Work Cycle for an Alternative Wheel Loader Concept”. International Exposition for Power Transmission (IFPE 2014) , ISBN: 0-942220-49-8, ch 11.1, Las Vegas, USA, March 4-8, 2014. (Endnote [16])
- V. Frank, B., “Using Optimal Control in Concept Evaluation and System Optimization of Diesel-Electric Hybrid Construction Machines” 4<sup>th</sup> International Conference on Electrical Systems for Aircraft, Railway, Ship propulsion and Road Vehicles & International Transportation Electrification Conference (ESARS ITEC 2016), Toulouse, France, November 2-4, 2016. (Endnote [9])
- VI. Frank, B., “Utilizing Optimal Control and Physical Measurements when Developing Operator Assist, Automatic Functions and Autonomous Machines” 6<sup>th</sup> IEEE International Conference on Control System, Computing and Engineering (ICCSCE 2016), Batu Ferringhi, Penang, Malaysia, November 25-27, 2016. (Endnote [10])

1<sup>st</sup> Author - Journal papers:

- VII. Frank, B., Kleinert, J., Filla, R., “Optimal Control of Wheel Loader Actuators in a Complete Work Cycle in Gravel Applications”. Automation in Construction, Volume 91, Pages 1-14, July 2018. (Endnote [50])

2<sup>nd</sup> or 3<sup>rd</sup> Author - Conference papers:

- VIII. Filla, R., Obermayr M., Frank, B., “A Study to Compare Trajectory Generation Algorithms for Automatic Bucket Filling in Wheel Loaders”. 3<sup>rd</sup> Commercial Vehicle Technology Symposium (CVT 2014), Kaiserslautern, Germany, March 11-13, 2014. (Endnote [33])
- IX. Samuelsson, T., Filla, R., Frank, B., Skogh, L., “Selecting Representative Working Cycles from Large Measurement Data Sets” 4<sup>th</sup> Commercial Vehicle Technology Symposium (CVT 2016), Kaiserslautern, Germany, March 8-10, 2016. (Endnote [102])
- X. Filla, R., Frank, B., “Towards Finding the Optimal Bucket Filling Strategy Through Simulation” 15<sup>th</sup> Scandinavian

International Conference on Fluid Power – Fluid Power in the Digital Age (SICFP' 17), June 7-9, 2017. (*Endnote [63]*)

2<sup>nd</sup> Author - Journal papers:

- XI. Nezhadali, V., Frank, B., Eriksson, L., "Wheel Loader Operation - Optimal Control Compared to Real Drive Experience". *Control Engineering Practice*, Volume 48, Pages 1-9, March 2016. (*Endnote [53]*)

Relevant supervised work:

- XII. Karlsson J., "Application and Material Identification for a Wheel Loader", Master Thesis, Mälardalens Högskola, 2010. (*Endnote [62]*)
- XIII. Ohlsson-Öhman, K., "Identifying Operator Usage of Wheel Loaders Utilizing Pattern Recognition Techniques", Master Thesis, Linköping University, 2011. (*Endnote [100]*)
- XIV. Nilsson, T., Sundström, C., Nyberg, P., Frisk, E., Krysander, M., "Robust Driving Pattern Detection and Identification with a Wheel Loader Application", *International journal of vehicle systems modeling and testing*, 9(1): 56-76, 2014. (*Endnote [99]*)
- XV. Samuelsson, T., "Automatic Selection of Representative Operating Cycle in Large Measurements", student summer work, Volvo internal report, 2014. (*Endnote [103]*)
- XVI. Palm, W., Skogh, M., "Wheel Loader Cycle Recognition Software Evaluation", student summer work, Volvo internal report, 2016. (*Endnote [101]*)

### **Declaration of Contribution**

Paper I is an initial literature study paper. The literature study was initiated by the co-authors, which were the supervisors at the time, and performed by Bobbie Frank, who also wrote the paper. The co-authors helped to review the paper.

In paper II Mats Alakiula came up with the initial idea to measure on many real operators. The measurements were coordinated by Lennart Skogh. All the analysis and algorithm development was done by Bobbie Frank, who also wrote the paper. The co-authors helped to review the paper.



In paper III, with the same background as paper II, Reno Filla added aspects of automation from the operators' point of view and proposed visualization of the data. All the analysis and algorithm development was done by Bobbie Frank, who also wrote the paper. The co-authors helped to review the paper.

In paper IV the development of the optimal control algorithms, using dynamic programming, was supervised and supported by Anders Fröberg. All algorithm development, measurements on customer site and comparison analysis was done by Bobbie Frank, who also wrote the paper. The co-author helped to review the paper.

In paper V all algorithm development, concept evaluation and system optimization was done by Bobbie Frank, who also wrote the paper.

In paper VI all algorithm development and operator comparison analysis was done by Bobbie Frank, who also wrote the paper.

In paper VII Jan Kleinert performed the gravel pile modeling and simulations, Reno Filla created the analytic trajectories and performed the post processing of the gravel pile simulation data while Bobbie Frank created the exhaustive search type trajectories, the optimal control algorithms, method development and the comparison analysis with the empirical study. Jonatan Blom supported with the initial recursive programming code. Jan Kleinert wrote the gravel simulation chapter and Bobbie Frank the rest of the paper, all co-authors and Johan Sjöberg helped to review the paper.

Paper VIII contains a detailed account for the analytical trajectories and gravel pile simulations used in paper VII. Reno Filla performed the analysis and wrote the paper, Martin Obermayr performed the gravel simulations and added text on the gravel simulation section and Bobbie Frank provided data from the empirical study presented in paper III. The co-authors helped to review the paper.

The initial idea for paper IX, with three different methods, came jointly from Bobbie Frank, Reno Filla and Lennart Skogh, who all supervised the work in report XV which the paper is based on. Ted Samuelsson developed the algorithms and co-wrote the paper with Reno Filla. The co-authors helped to review the paper.

Paper X covers learning's from paper VII and VIII. Most of the analysis was done by Reno Filla, who also wrote the paper. Bobbie Frank provided data and performed some analysis. The co-author helped to review the paper.

In paper XI the optimal control algorithm development was done by Vaheed Nezhadali, who also wrote the paper. Bobbie Frank provided the measurements from the operator deviation study presented in paper II and revised the paper. The co-authors helped to review the paper.

The initial idea to thesis XII came from Bobbie Frank, who also supervised the thesis work. Jan Karlsson did all the work.

The initial idea to thesis XIII came from Bobbie Frank, and is a continuation on the work in paper XIV, who also supervised the thesis work. Karin Ohlsson-Öhman did all the work.

The initial idea to paper XIV came from Bobbie Frank, as a continuation from thesis XII, who also were the supervisor from the industry. The work was performed as a PhD course. Tomas Nilsson, Christofer Sundström and Peter Nyberg did all the work. Erik Frisk and Mattias Krysander were supervisors from the university.

The initial idea to report XV, with three different methods, came jointly from Bobbie Frank, Reno Filla and Lennart Skogh who all supervised the student summer work. Ted Samuelsson performed all the work.

The initial idea to report XVI came from Bobbie Frank, as a continuation to the work in thesis XII, thesis XIII and paper XIV. William Palm and Mårten Skogh performed all the work.

## **1.7 Thesis Outline**

In Chapter 1, an introduction and wheel loader background is given to understand the problem at hand. The research goals and contributions are also addressed, including a listing of the publications that this thesis is based on.

In Chapter 2, the operator deviation measurements, with analysis, resulting in finding the empirical optimum and the potential with operator assist and automatic functions are described in detail.

In Chapter 3, the theoretical global optimum, based on the optimal control method dynamic programming, for a complete wheel loader work cycle is calculated.

In Chapter 4, a comparison analysis between the measured empirical optimum, from Chapter 2, and the calculated theoretical global optimum, from Chapter 3, is performed.

In Chapter 5, the results from a concept evaluation and system

optimization performed with the developed optimization tool, based on the optimal control algorithms in Chapter 3, are presented.

In Chapter 6, the results regarding to use the output from the optimal control calculations, from Chapter 5, as input to the development of operator assist systems, automatic functions and autonomous machine control are presented.

Chapter 7 contains a discussion regarding the results presented in Chapter 5 and Chapter 6 together with the limitations of the optimization tool in its current development state. Some ideas for future work within the addressed areas are also presented in this chapter.

Finally, in Chapter 8, the conclusions of this thesis are presented.



## Chapter 2

# Empirical Optimum Study

The *primary* objective in this chapter is to find the productivity and fuel efficiency optimum in the operation of a wheel loader by empirical means. The result from this empirical study is used to challenge the calculated theoretical global optimum from Chapter 3 in Chapter 4. The *secondary* objective is to investigate the potential for fuel efficiency increase with operator assist, automatic functions and autonomous machines. This is accomplished by investigating the fuel efficiency and productivity difference of a wheel loader caused by differences in operator behavior, using a bucket application in a production chain as an example.

When performing measurements intended to meet the stated objectives, the most important factor is to try to eliminate all other parameters not affected by the operator, but still maintain as close to realistic conditions as possible. It was decided to do the measurements in real world operations and not in a wheel loader training simulator, where it would have been easier to control the machine setup and environmental conditions. Selecting real world operation is due to two main reasons: the training simulator is just a model that does not exactly correspond to the real world accurately enough, with respect to fuel consumption and loaded material in the bucket. Hence, it is hard to get the correct fuel efficiency and productivity. The skill transfer is also not necessarily correlate well from the training simulator to a real world operation [57], or vice versa. Also, some more inexperienced operators get a more “video-game feeling”, not corresponding to how they would operate a wheel loader in the real world, primarily with regard to risk-taking and safe operating.

To capture some of the versatile usage of the wheel loader, three different bucket applications with different work cycles and different

degrees of difficulty when it comes to bucket fill were investigated:

1. “Short loading cycle”, loading gravel onto a load receiver, as visualized in Fig. 1.3. This is a typical rehandling application where processed material is stock-piled and then a wheel loader loads outgoing trucks from the site, see picture in Fig. 2.1.



Fig. 2.1 Measurement setup for the “short loading cycle gravel”.

2. “Load and carry” uphill to a pocket, loading gravel. This is a longer cycle than the “short loading” cycle in Fig. 1.3, where the distance between point ② and ③ is not 10-15m as in the “short loading cycle” but rather 100-150m, carrying load uphill. The load receiver is also exchanged to a hopper that goes to a conveyer belt. This would also be a typical rehandling application where pre-crushed material is either stock-piled or the wheel loader unloads the material into a hopper that goes to the next step in the production chain, for example another crusher or sorting machine, see picture in Fig. 2.2.



Fig. 2.2 Measurement setup for the “load and carry gravel”. Left; the gravel pile during the bucket fill phase. Right; aerial view of the route from the gravel pile to the hopper.

3. “Short loading cycle” onto a load receiver, as visualized in Fig. 1.3, loading rock. This would correspond to a face application where the wheel loader is loading blasted shot rock from face similar to the work done in Fig. 1.1. In this application, it is much harder to fill the bucket, meant to differentiate the operators a bit more than just loading gravel which is quite easy to fill the bucket with, see picture in Fig. 2.3.



Fig. 2.3 Measurement setup for the “short loading cycle rock”.

## 2.1 Measurement Setup

As mentioned above, the most important factor in this test is to isolate the *operator behavior* as the sole source of deviations. This was accomplished by, in all three applications, using the same machine with the same equipment, i.e. same bucket, tires etc., for all operators to minimize the *machine specification* dependence. In the same manner, the

same gravel pile, with predefined material, was used for all operators to minimize the *working environment* dependence. Using the same gravel for all operators minimizes the deviation in bucket fill easiness, hence also differences in fuel efficiency and productivity.

240 measurements, 80 in each of the three applications, operating the wheel loader for 20 minutes or 15 work cycles whatever comes first were recorded with 73 operators. Four groups of operators were considered and included in the study:

1. *Novice operators*, who have 2-10 hours wheel loader experience.
2. *Average operators*, who know how a wheel loader works but do not operate wheel loaders as a profession.
3. *Internal professional operators*, who evaluate wheel loaders as a profession, work as test operators and/or show operators and/or trainers at Volvo Construction Equipment.
4. *External professional operators*, who work every day operating larger wheel loaders in bucket applications in production chains as a profession.

The initial idea was to have 16 operators in each group, simply because this was the highest reasonable number to measure in this large extent and still be able to freeze the surrounding parameters; *machine specification* and *working environment*. However the measurements ended up with a few extra operators due to the fact that when searching for external professional operators more than 16 customers showed interest. Ultimately it was decided by Volvo that all customers interested should be allowed to attend the event. Some extra average operators were added because the personnel that performed the measurements wanted to be included in the investigation. This is why the number of operators is not the same in the four groups.

Three of the most experienced internal test operators were assigned to perform “intensity measurements”. This means that they were supposed to operate the wheel loader in three different intensities:

1. *Calm and relaxed* driving, with a slightly lower bucket fill factor.
2. *Normal driving pace* and medium bucket fill factor, corresponding to what to expect when operating the wheel loader in 8 hour shifts,



3. *Aggressive and fast* driving with as high bucket fill factor as possible, corresponding to a pace that only could be maintained by an operator for less than one hour due to the high mental and physical workload.

The purpose for these intensity measurements is to map the complete wheel loader working area with respect to productivity versus fuel efficiency. All other operators were asked to operate the wheel loader at a pace corresponding to how they would work if they were supposed to work an eight hour shift in the specified work assignment.

Some factors, such as the weather, could not be controlled during the complete measurement. Unfortunately the applications “load and carry gravel” and “short loading cycle rock” that took place outdoors were affected by the weather conditions, especially because the material is heavier when it is wet, which increases the load weight, hence affecting the productivity and fuel efficiency. The weather conditions during the measurements were typical Swedish late summer/early autumn which is very changing, meaning that the material was fairly moist in all the measurements but at various levels. In the “short loading cycle gravel”, the measurements were conducted indoors, consequently also unaffected by the weather conditions. During the measurements some additional unexpected issues were experienced. Over time, the aggregate material was worn, resulting in a larger fraction of finer material, which means a higher density, especially in the “load and carry gravel” measurement. In consequence, it was easier to get a heavier load in the bucket at the end of the measurement, hence also easier to get higher productivity and fuel efficiency. In the “load and carry” application the more extensive material wear was due to wear against the conveyer belt and hopper. In the rock application the material, boulders and shot rock, the material breaks apart more easily, rounding the edges, which changes the material properties. This results in higher uncertainties regarding material wear in these two applications. In the “short loading cycle gravel” the wear was not as severe as in the other two applications and after analyzing measurement data in conjunction with what had been observed during the measurements this did not affect the results much in the “short loading cycle gravel” application. This is also the reason why the indoor, most repetitive application is used as a comparison henceforth.

Furthermore the wheel loader in the “short loading cycle rock” had a minor problem with a hydraulic regulator which affected a handful of the measurements due to that it is more difficult to operate the machine in this condition. Another problem experienced was that the measurement system did not work properly due to a faulty cable. The faulty cable resulted in loss of data for one external operator in the “load and carry gravel” and five external operators in the “short loading cycle rock” resulting in an uneven number of results from the measured operators.

Last, the rock application is not really representative to a real shot rock application that can be observed at customer sites. This was purposely initiated for two reasons: for one, it would be unsafe and unwise to permit novice operators to operate in a “real” shot rock application due to the high risk of slicing the tires. Secondly, the rock-like application that was used during the measurements was more repeatable than “real” shot rock could ever be arranged to be. The final result is that the pile can be seen as practically the same for all operators, which would not be the case if using “real” blasted shot rock.

However, after investigating and comparing the three different applications the conclusion was that the weather, wear of material and hydraulic regulator malfunction did not affect the analysis to a significant extent. Hence, the results are valid but one can still have these factors in mind, especially considering the “load and carry gravel” and “short loading cycle rock”. The application least affected by these uncertainties was the “short loading cycle” gravel. This is why these measurements are used as an example in the following chapters.

## **2.2 Data Analysis**

As the focus is on investigating the fuel efficiency and productivity difference of a wheel loader caused by differences in operator behavior particular, the attention was put to measure the time and bucket load as accurately as possible. This is since these parameters are the most significant in the fuel efficiency and productivity calculations. The analysis is done in three levels: “Complete Run”, “Individual Work Cycle” and “Work Phase Level”.

### **Complete Run**

The first level of analysis is on an average for the complete run, on all 15 work cycles. At this level the most important factor was to only count the wheel loader work cycle. When the articulated hauler was away emptying in the “short loading cycles gravel or rock” or if there were any problems with the conveyer belt in the “load and carry gravel” that fuel and time was excluded from the wheel loader work cycle. This was accomplished by instructing the operators to cease wheel loader operation through neutral gear engagement. Subsequently, the data was processed so the dataset was reduced to only include the time when the wheel loader was working. The weighing system, that weighs the load in the bucket, was the only source of fault identified in this level and occasionally failed to weigh a load. A correcting algorithm was created by adding an average bucket load for every missed load. The maximum allowed percentage of missed loads was set to twenty percent. If more than that was observed, the measurement was seen as corrupt and not used. There is a high confidence that using an average bucket load value for the missing loads does not distort the results significantly at this level, since at the end it is the average of all cycles what matters for the analysis.

The first level in the analysis, on the complete run, is used for evaluating individual operators and comparing operators to each other with regard to fuel efficiency and productivity. Average values are easy to assimilate for operators because these values are shown in the daily work on many work sites today.

The difference, with regard to fuel efficiency and productivity, between a diversity of operators is very large. Comparing operators, the difference can be as high as five to eight times higher productivity and two to three times higher fuel efficiency, depending on application. Refer to Fig. 2.4 where a visualization of such differences is shown.

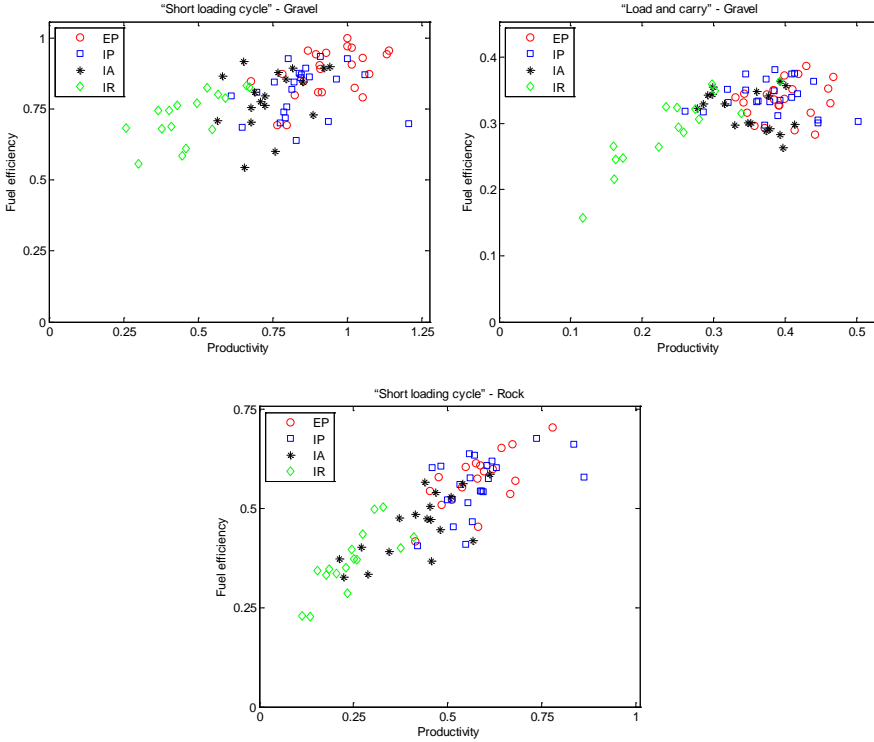

Fig. 2.4 Average fuel efficiency and productivity results for all the operators. EP is the external professional, IP is the internal professional, IA is the average and IR is the novice operators [13]. Normalized, to the most fuel efficient operator's average in the "Short loading cycle" - Gravel, due to intellectual properties.

It is however a bit unfair to compare the extremes, since an operator is not a novice for a long period of time. Yet, even if the novice operators are excluded, the difference between the non-novice operators is up to two to four times higher productivity and up to 1.5 to 2.5 times higher fuel efficiency, as can be seen in Fig. 2.4. An interesting exception could be day-to-day workers, often in third world countries, where many possess little or no experience. However, this class of operators is a very small fraction of the total, when considering the total world market.

It can also be observed that both the fuel efficiency and the productivity seem to have a somewhat linear dependence with regard to the experience,

or skill level, of the operators participating in the measurement for each application in Fig. 2.4. The closer an operator is to the upper right corner, the better that operator is at operating the wheel loader with regard to fuel efficiency and productivity. An additional important parameter to consider when stating the operator performance, is the maintenance cost which is not analyzed here. The exceptions are the intensity measurement study, where the test operators were asked to stress the machine and themselves to an abnormal behavior.

Interesting results that can be seen in Fig. 2.4 is the dependence on application, in the “short loading cycle” - gravel the operators are closer to each other than in the other two applications. In the “load and carry” - gravel case the operators are deviating more from each other. This is because the bucket fill factor is much more important when the load is transported over a longer distance. A larger amount of fuel is consumed in the longer “Transport” phase, resulting in that a small difference in the bucket fill factor affects the fuel efficiency and the productivity to a larger extent. In the rock application, the difference is larger, since it is much more difficult to fill the bucket with rocks and there is an uncertainty of the quantities of various sized aggregates entering the bucket. Large rocks or higher quantities of fine material contributed to larger deviation between the operators and the individual cycles of each operator.

### **Individual Work Cycle**

The second level of analysis is on work cycle basis. Within this level, the fuel efficiency and productivity per work cycle is calculated. This is done by identifying a point in the working cycle that is easy to detect and occurs at the same time every cycle. The only point that was feasible to detect reliably in an automatic way was the positioning point of the bucket just before entering the pile. Other points could not be used because of problems with the weighing system and unexpected operating behavior, especially by the novice operators. The positioning point can move a bit, distance wise, in the cycle depending on if the operator decides to lower the bucket and clean the ground on the way into the pile. This results in that the cycle times are a bit more uncertain. Even though the average is correct, the cycle time in the analysis can differ some seconds from the value that would be obtained if using a stopwatch. This affects the fuel efficiency and productivity for isolated cycles.

The second level is used to see a pattern regarding the 1<sup>st</sup>, 2<sup>nd</sup> and 3<sup>rd</sup> work cycles when loading material onto the load receiver. The operators can also see which cycle yields the best results and how that differs from the other cycles. In this way the operators can compare good and bad results and more importantly, learn from mistakes and improve their skills. The cycle values of fuel efficiency and productivity are also used to establish a trade-off curve for a specific wheel loader in that specific work assignment. The trade-off curve shows the highest possible fuel efficiency for a given productivity within the wheel loader working range. Hence these trade-off curves can then be used to evaluate how much better an operator can become in that application, operating that specific wheel loader. This curve of course depend on the number and skill level of the operators in the study and is not the absolute maximum but rather a way to showcase the method and how an operator training tool could look like if a larger base of operators was used. This is important to realize when going from an empirical study like this to an estimation of fuel consumption savings. Additionally, this is a conservative way to look at the savings due to the fact that the probability the best operator in the world were participating in the study is small. Another important aspect is that operating at the highest fuel efficiency does not have to be the best for the customer. If a higher productivity is demanded this can be traded against lower fuel efficiency or whatever that is required for that customer in that specific situation. That is why it is important to have the trade-off curve for the complete working area of the wheel loader and application in mind, rather than just an optimal operating point. In the same way, it is only possible to increase productivity, allowing higher fuel efficiency if the site conditions allow intermittent operation.

An interesting observation is that every operator has a quite large deviation from its own average fuel efficiency and productivity. In Fig. 2.5, the cycle distribution of operator IA1 is shown, with the average value displayed with a larger marker, together with all the other operators' average. From the data shown in Fig. 2.5 it can be deduced that if operator IA1 operated the wheel loader at the best point achieved then the average fuel efficiency would increase with about 10-15% and the productivity by around 10%. Alternatively, the operator could increase the productivity by approximately 20% and the fuel efficiency by a few percent, all depending on the current site boundary conditions.

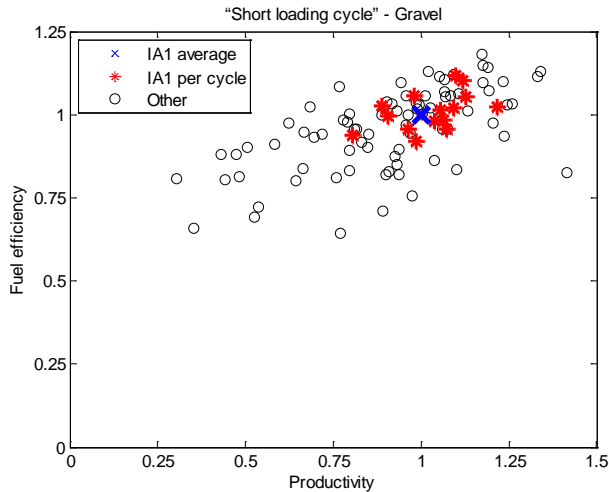

Fig. 2.5 Fuel efficiency and productivity distribution for one operator's individual work cycles in comparison to all the other operators' average [13]. Normalized, to IA1's average, due to intellectual properties.

Some deviation between the individual cycles when loading a load receiver is inevitable. The 3<sup>rd</sup> bucket load onto the load receiver has to be positioned more carefully in order not to spill material outside the load receiver, due to that it is filling up. Another parameter to take into consideration is at the 1<sup>st</sup> cycle in which the loader has to be positioned towards the pile due to the fact that the gravel is reused, see Fig. 2.1. "Short loading cycle" in gravel for one operator with the other operators' average in the background is shown as an example in Fig. 2.5. However, similar behavior is apparent in all three applications and it is evident when analyzing the individual work cycles, see Fig. 2.6 for "short loading cycle", that the around 10-15% fuel efficiency and productivity deviation between individual cycles for an operator cannot entirely be explained by the work cycle number difference.

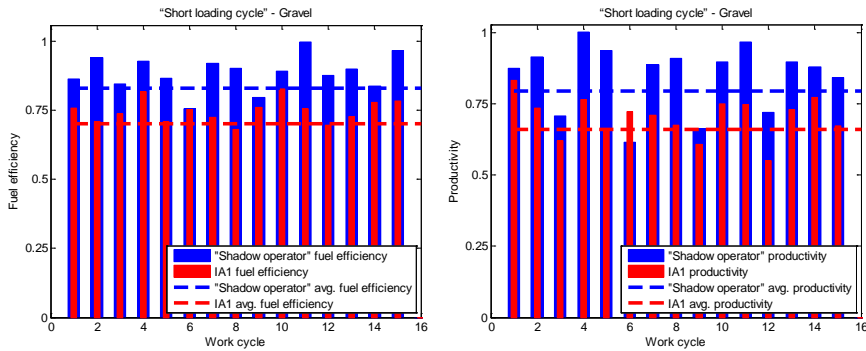

Fig. 2.6 Fuel efficiency and productivity in average and per work cycle for IA1, in Fig. 2.5, and the operator with the highest fuel efficiency, the “Shadow operator”. Normalized, to highest cycle value, due to intellectual properties.

Two approaches can be considered to get the machine trade-off curve. Either the convex hull of all the operators’ average cycles in Fig. 2.4 represents a Pareto front, or the convex hull of each and every individual cycle for all operators combined, like the example shown in Fig. 2.5 for IA1. Due to the concerns regarding the cycle time raised previously, the convex hull has to be slightly modified to take away outliers that are unreasonable. This could be avoided with better measurement and analysis strategy, e.g. by performing the analysis without the novice operators to avoid many of the unexpected operator behavior. In Fig. 2.7 the two different trade-off curves are plotted using the two proposed methods, average cycle and all individual cycles, mentioned above.



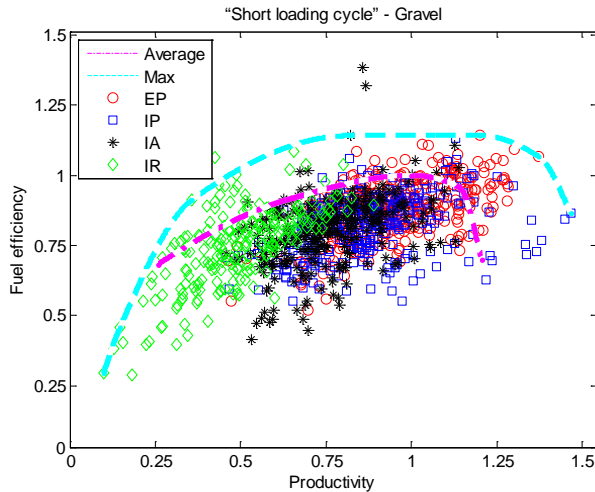

Fig. 2.7 All the operator’s individual “short loading cycle” gravel cycles with the trade-off curves from the each operator’s average cycle, “Average”, and from the individual cycles, “Max” [13]. Normalized, to the most fuel efficient operator’s average in the “Short loading cycle” – Gravel in Fig. 2.4, due to intellectual properties.

The “Max” trade-off curve, which is the modified convex hull excluding the outliers for all the measured individual cycles, is the correct trade-off curve for this specific wheel loader in this specific application and work cycle. However, to some extent the difference between the 1<sup>st</sup>, 2<sup>nd</sup> and 3<sup>rd</sup> work cycle, as discussed earlier, has to be accounted for which can explain some of the difference between the “Max” and “Average” curve. For the selection of operators in this study, the “Average” machine trade-off curve should be able to be raised to around half of the distance up to the “Max” curve, meaning approximately a 10% fuel efficiency increase, depending on the productivity demand, according to the discussion in conjunction with Fig. 2.5 and Fig. 2.6. This is because the differences between 1<sup>st</sup>, 2<sup>nd</sup> and 3<sup>rd</sup> work cycle could be reduced if the work is planned further in advance and executed accordingly. The “short loading cycle” in gravel is shown as an example in Fig. 2.7 but similar results can be obtained in the other two applications.

These two approaches are under the assumption that the measurements have been conducted on an infinite number of operators. Although this is

not the case, the method is still valid and the only difference is that the estimations can be accepted as conservative since, with the highest probability, not all the best operators in world participated this study.

If the conditions on the site allow that the wheel loader to work part time additional fuel can be saved, since the wheel loader can operate only at the optimal productivity resulting in up to 20% fuel efficiency increase, depending on the required productivity, comparing e.g. between 35% and 75% of productivity in Fig. 2.7. This also means that if the site manager knows the trade-off curve for the specific application, for the specific wheel loader and all the other machines in the production chain, the site can be planned accordingly to optimize the complete site fuel efficiency and productivity.

The shape and characteristics of the trade-off curve can be explained by analyzing the efficiency maps for the constituting subsystems and components in the wheel loader. The reason why both fuel efficiency and productivity goes towards origin in Fig. 2.7 is not that surprising. If just standing still, or just driving around, then fuel and time is wasted while no material is moved, hence both the productivity and the fuel efficiency are zero. The trade-off curve then flattens, which is the “sweet spot” with regards to fuel efficiency, and finally goes down a bit, at high productivity, due to the fact that there are components with speed related losses that increase proportionally to the square of the speed, and therefore become more significant for these operation conditions. Also most components are tuned to have their maximum efficiency at lower speeds than the ones that are necessary when the wheel loader is stressed to its maximum capacity. Typically a wheel loader is laid out to have the maximum fuel efficiency at around 70-80% of the maximum productivity [26,58,59,60].

### Work Phase Level

The third level of analysis is on work phase basis [1,32,61,62]. Here the cycles are divided into three phases; “*Bucket Fill*”, “*Transport*” and “*Bucket Empty*”, see Fig. 1.3. These phases are distinguished by a number of conditions resulting in that:

- “*Bucket Fill*” is from when the bucket gets close enough to the ground until the operator set the gear shift lever in reverse and leaving the pile.

- “*Bucket Empty*” is from when the operator lifts the bucket to a certain height and then until the bucket comes down to a low enough height again after moving towards the load receiver, the emptying and after that starting to reverse from the load receiver.
- “*Transport*” is the rest, loaded and unloaded, forward and reverse.

The difficulties, to detect fix points in the work cycle reliably in an automatic way, in the second level, Individual Work Cycle, apply to this level as well, hence the exact times for each phase are an approximation based on that the points that divides the work cycle into work phases can change a bit depending on how the operator execute the work cycle.

The work phase level is used to investigate what was done correctly, or incorrectly, in closer detail than on complete work cycle level, and how each phase correlate to each other and to the complete work cycle performance. From this, it can be concluded which phase is the most important factor for a specific operator to adjust to increase the fuel efficiency and productivity and what particular operation in that phase can be improved. In order to show the operator what happened during a specific cycle, the individual signals measured, corresponding to what the operator feels, hears or sees are presented. Examples of these signals are the engine torque, engine speed, actuator speed on one hand, and also the actuation signals, the lift and tilt levers and the accelerator and brake pedals on the other hand. From this, the operator can learn the system and analyze the impact of different operator behavior. This can be presented as valuable feedback through a training tool or operator assist system. Another opportunity is that each operator can compare with the “Shadow operator” which is the “optimal” operator. In this example the “Shadow operator” is the operator with the highest average fuel efficiency in the study but it could also be a virtual operator, which can correspond to the theoretical global optimum calculated in Chapter 3. In a simulator it is easier to implement the calculated virtual operator due to the controlled environment.

Fuel efficiency and productivity for each phase is also calculated, but it turns out that these parameters are not good indicators of how well each phase was performed when considering the complete work cycle. As can be seen in Fig. 2.8, there are no correlation between the fuel efficiency, inverted fuel efficiency is plotted for visualization purposes, in the complete work cycle and any of the phases; “*Bucket Fill*”, “*Bucket Empty*”

and “*Transport*”. To be able to do a proficient complete cycle all phases has to be well performed. Regarding the productivity, inverted productivity is plotted for visualization purposes, a slight correlation can be seen between the complete work cycle and the bucket empty phase. This is however due to that the operator at hand is hesitating in the bucket empty, taking too long time, hence this phase gets more predominant than in a case where the operator is more skilled.

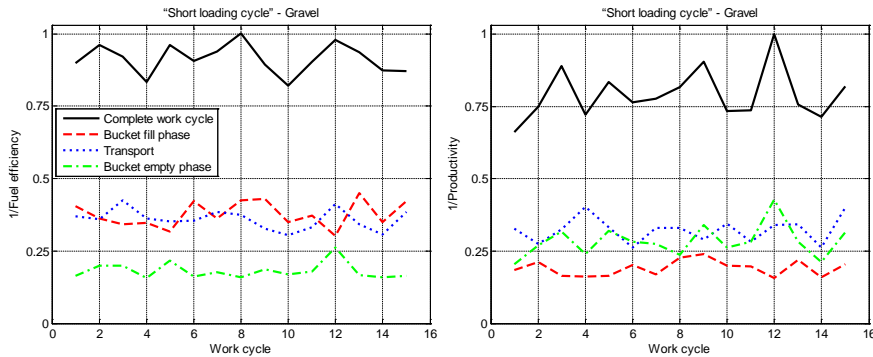

Fig. 2.8 Comparison of the inverted fuel efficiency [l/ton] to the left and inverted productivity [h/ton] to the right between the complete work cycle, the bucket fill phase, the transport and the bucket empty phase. Lower is better. Normalized, to highest cycle value, due to intellectual properties.

The reason is that an operator can sub-optimize in one phase, for example in the bucket fill, by only filling the bucket very little and very quick, by using only the machine inertia. In that case, an operator can get very high fuel efficiency and productivity in the bucket filling phase, but lose a lot in the other two phases, transport and bucket empty. This is due to the very light load in the bucket is resulting in very low fuel efficiency and productivity in the complete cycle due to much lower payload percentage.

However, as indicated in the text above, there is a clear relationship between a well performed bucket fill phase, with a lot of material in the bucket, and a well performed complete work cycle with high fuel efficiency and productivity. Even if a well performed bucket fill phase not necessarily results in a well performed complete work cycle, a well

performed complete work cycle always contain a well performed bucket fill phase. This indicates that the “*Bucket Fill*” phase is very important for the complete cycle performance. This can also be derived by compiling a set of complete cycle performance indicators, as shown in Fig. 2.9.

To increase the fuel efficiency, at a given productivity, or to increase the productivity, the bucket fill phase stands out as the most critical when comparing the fuel efficiency and productivity results between the operators. Not only do most operators spend the majority of the extra fuel consumed compared to the “Shadow operator” in the bucket fill phase, see Fig. 2.10, but if a smaller amount of load is excavated in the bucket fill phase this affects the fuel efficiency and productivity of the total work cycle, as can be seen for some of the operators on the right in Fig. 2.9. This implies that to increase the fuel efficiency, the bucket fill is the most critical phase where to help the operator to solve the work assignment in the best possible way. Also from Fig. 2.9 and Fig. 2.10 it becomes clear that low amount of fuel used in the bucket fill phase is not a good performance indicator, because if the amount of load, implicitly the fuel efficiency and productivity in the complete work cycle, is not considered the complete work cycle results can be non-optimal. Fortunately, the bucket fill phase is quite an isolated incident that is rather suitable to do automatically; the operator gives the command and the wheel loader fills the bucket as close to the optimum fuel efficiency and productivity as possible. There are of course challenges to develop an automatic bucket fill as well, e.g., but not limited to; how to fill the bucket in an optimal way depending on ground and gravel pile material properties, where the gravel pile starts, what kind of bucket, etc. [63].

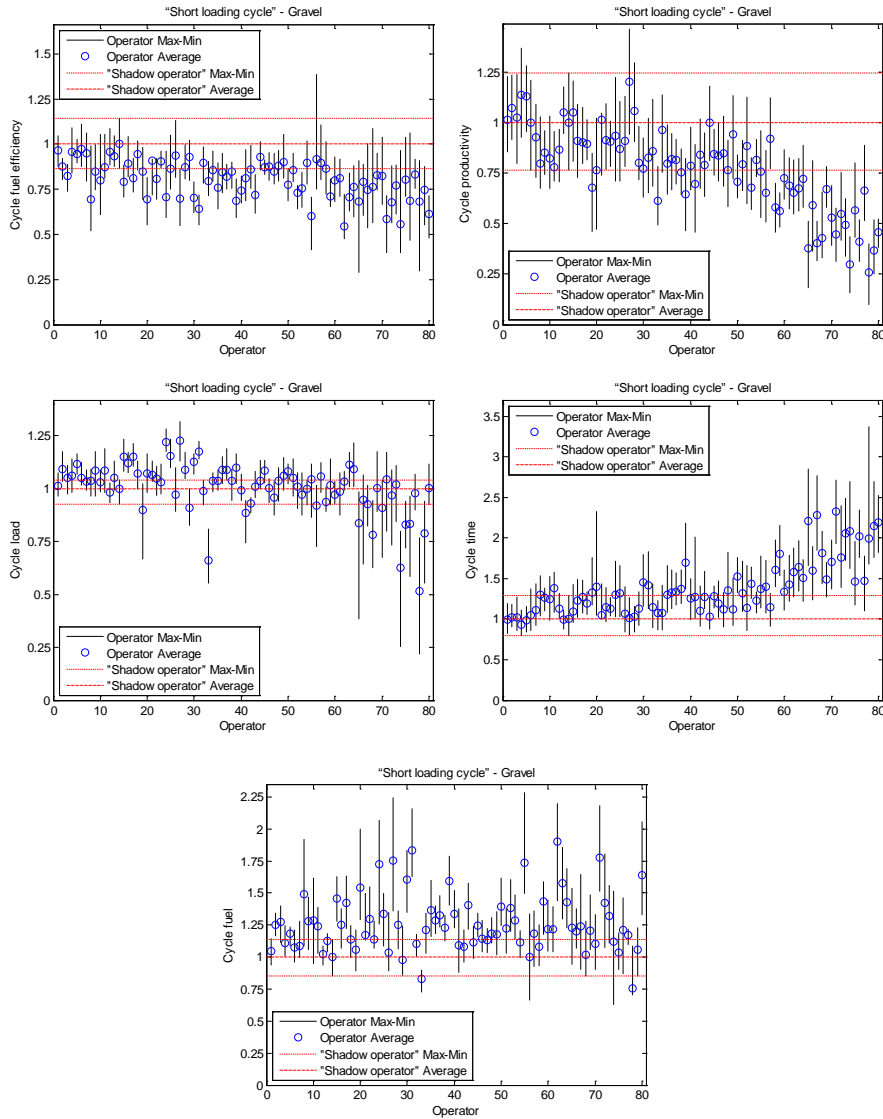

Fig. 2.9 A comparison between all the operators and the “Shadow operator” with regard to fuel efficiency, productivity, load in the bucket, fuel per cycle and cycle time. Normalized, to the “Shadow operator” average, due to intellectual properties.

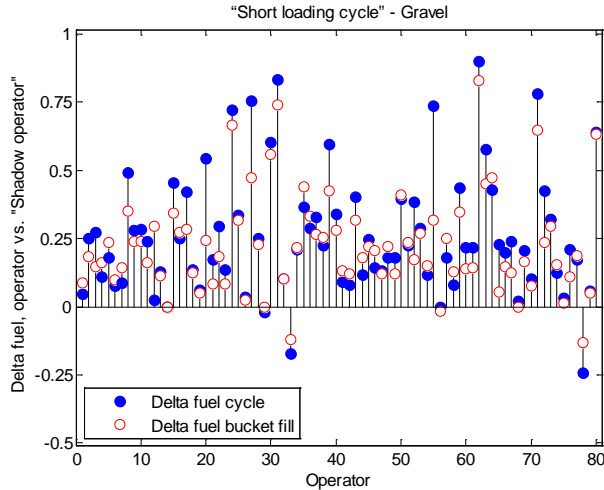

Fig. 2.10 The difference in fuel used in a complete cycle and in the bucket fill phase for all the operators, comparing to the “Shadow operator”. Normalized, to the “Shadow operator”, due to intellectual properties.

Fig. 2.10 shows with blue dots how much more fuel each operator consumes on average per cycle in comparison to the “Shadow operator”. The red rings in the plot show how much the bucket filling phase contributes to that additional fuel consumption per cycle. It is debatable if the delta fuel per phase and complete work cycle used in Fig. 2.10 is the correct performance indicator because some operators manage to consume less fuel than the most efficient “Shadow operator”. However, Fig. 2.9 reveals that this is due to less amount of load in the bucket, i.e. in terms of fuel efficiency they are still worse than the “Shadow operator” as their decrease in fuel consumption doesn’t make up for their decrease in bucket load.

## 2.3 Operator Training Tool

An example of a simple off-line training tool was derived from the analysis of the empirical study measurements. The training tool is based on a report that the operator receives after fulfilling a certain task with the machine, in order to analyze where to make necessary adjustments to improve the fuel efficiency and the productivity. The report is

automatically generated from measurements in Matlab. The content and layout of the report is explained in the remaining of this chapter.

The proposed training tool works just as well in a simulator as in a real wheel loader, but there are benefits and drawbacks to both of them. In a real wheel loader, the difficulties to accurately measure over and over again, identifying specific point in the work cycle, for example where the gravel pile starts, having the same gravel pile and taking weather conditions into account is discussed above. Having a critical mass of operators to compare at one site within a limited period of time and to minimize the environmental factors for all the operators must be considered. In a simulator, the problem arise from participants experiencing a more “playing a video-game” feeling [57], which is not the same as operating a real wheel loader, as discussed earlier. There are also other barriers, such as trust in simulators, to overcome when using simulators in operator training of construction equipment [64].

The proposed training tool is built in a way so that it selects what is considered the optimal operator given the circumstances. For a given set of operators, the training tool chooses the one that exhibits the highest fuel efficiency, productivity, or a combination of the two, depending on what the optimization criterion is. In the example within this study, the optimal operator is chosen to be the one with the highest average fuel efficiency, but the optimal operator could just as well be chosen to be the operator that has the work cycle with the highest fuel efficiency or productivity. Another possibility is to use a virtual operator, consisting of the best recorded cycle for each of the three phases: bucket fill, transport and bucket empty. The optimal operator can also be a synthetic operator that reaches the theoretical global optimum calculated in Chapter 3, especially in a simulator edition. If the global optimum is used a more advanced operator assist system can be developed, as further presented in Chapter 6.

The proposed training tool takes the optimal operator and set this to be the “Shadow operator”, in this case the operator EP15 which is the operator with the highest average fuel efficiency. Then the operators compare themselves to the “Shadow operator” in the report. The goal is that the operators that had joined the training should be able to understand what the “optimal” operator performed better. For that reason, the training tool is built on the three levels discussed in Chapter 2.2. The operator can identify his/her performance, with regard to fuel efficiency and productivity, compared to the “Shadow operator” as visualized in Fig. 2.4.



Additionally, the operator's own potential is analyzed in a plot, as seen in Fig. 2.5, to enable visualizing how good the fuel efficiency and productivity of the individual best cycles are in comparison to the "Shadow operator". The operator is able to investigate at yet one level deeper by looking at individual parameters within individual cycles that have a direct correlation with the fuel efficiency and productivity, such as cycle times and load in the bucket. A proposed illustration for operator IA1 is depicted in Fig. 2.11. The operator also gets the fuel efficiency and productivity in a bar diagram format so the correlation between a well performed cycle and how the operator controlled the wheel loader in a particular cycle can be analyzed.

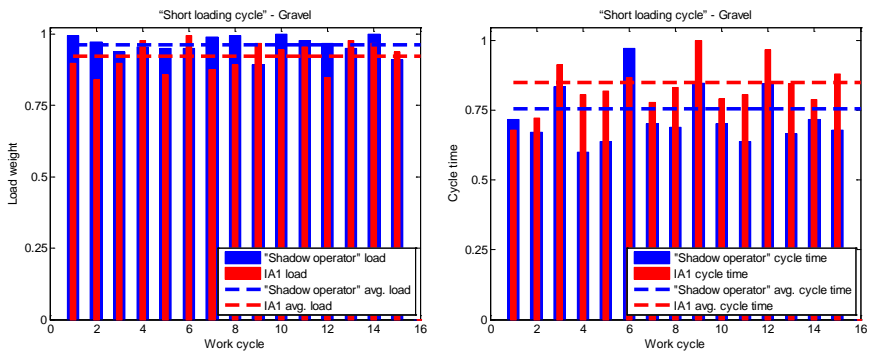

Fig. 2.11 The cycle time and load in the bucket per cycle in bar diagrams are shown as an example from the highest level of the training tool. Normalized, to highest cycle value, due to intellectual properties.

After observing Fig. 2.11, it is quite evident why the operator IA1 gets lower fuel efficiency and productivity versus the "Shadow operator". The cycle times are too long and the bucket loads are too low which results in lower fuel efficiency and productivity.

To understand the high level parameters, e.g. the cycle time and bucket load, the operator can go one level deeper in the analysis and cover all the parameters listed in Table 1. More importantly, a follow-up can be arranged to assess how the operator's values differs from the "Shadow operator". The majority of the operators should be able to remember how it was in the wheel loader when operating, especially if the feedback comes directly after operating. Important impressions from the wheel loader should be represented in the bar diagrams: hearing and feeling the

speed and torque of the engine when operating, seeing the velocity of the machine, the lift and tilt and how the operator actuates the three different actuators: propulsion, lifting and tilting. An example of how this level can be illustrated is shown in Fig. 2.12.

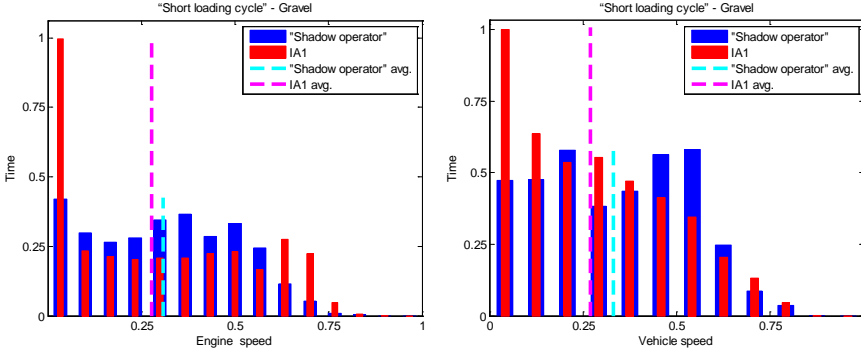

Fig. 2.12 Examples of bar diagrams from the training tools mid-level showing how much time per cycle in average the operator has spent in each engine speed and machine velocity bin. Normalized, to highest cycle and bin value, due to intellectual properties.

At this level operator IA1 can begin the process of understanding why his/her cycle time is higher than for the “Shadow operator”. The operator IA1 has much more idling time per cycle, in this case predominately in the “Bucket Empty” phase. Also the speed of the machine is lower indicating that the transport phase takes a longer time. Both are visible in the next, lower level. Another observation is that the operator IA1 does not utilize the engine as much as the “Shadow operator”. To understand how this affects the load, the “Bucket Fill” can be analyzed at the next, lower level where the work cycles have been broken down in the three phases: “Bucket Fill”, “Transport” and “Bucket Empty”. An example of how that can be illustrated, when analyzing how the actuators are controlled, is visible in Fig. 2.13.

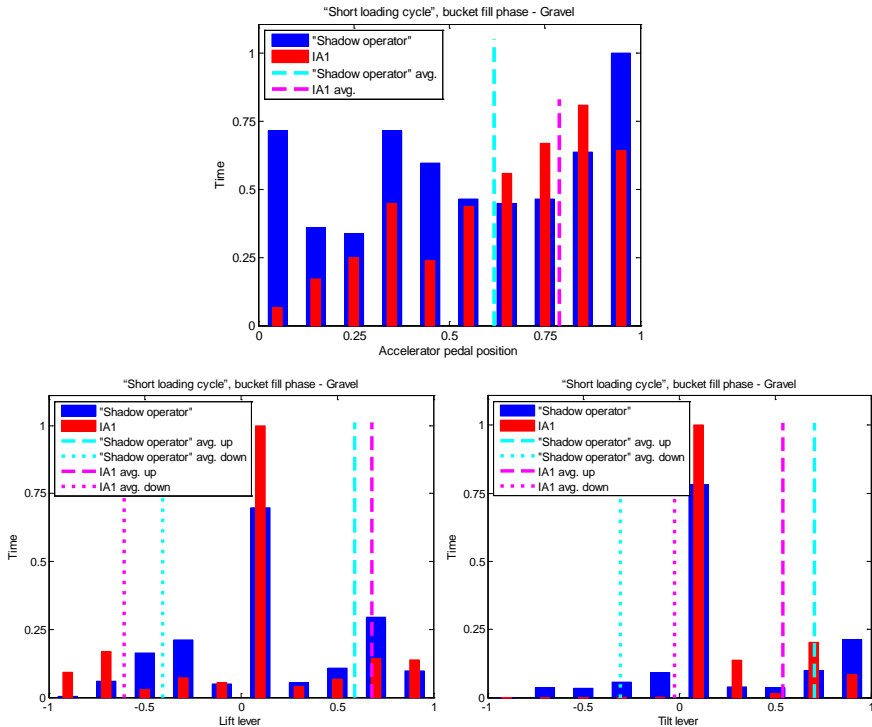

Fig. 2.13 Examples of bar diagrams from the training tool lowest level showing how much time in the bucket filling phase in average the operator have spent in each actuator controller bin. Normalized, to highest cycle and bin value, due to intellectual properties.

Once again, it is visible for the operator IA1 what could be improved. In this case, operator IA1 is too gentle on all actuators and cannot control the wheel loader as fast as the "Shadow operator". Furthermore, to achieve the same fuel efficiency and productivity as the "Shadow operator", the operator IA1 has to utilize the wheel loader capacity to a larger extent. In order to accomplish this, the IA1 operator has to learn how to control the wheel loader faster by actuating, simultaneously at times, the three main actuators: lift, tilt and propulsion. Listed in Table 1 are all the measured signals and the calculated performance indicators shown to the operators for the three levels in the training tool.

Table 1 Content of the training tool with regard to the different parameters analyzed per level.

Parameter	Unit	Average	Per cycle	Per phase
Fuel efficiency	[ton/l]	✓	✓	✗
Productivity	[ton/h]	✓	✓	✗
Load in the bucket	[kg]	✗	✓	✗
Cycle time	[s]	✗	✓	✗
Phase time	[s]	✗	✗	✓
Accumulated fuel	[l]	✗	✓	✓
Fuel consumption	[l/h]	✗	✓	✓
Distance	[m]	✗	✓	✓
Speed	[km/h]	✗	✓	✓
Accelerator pedal position	[%]	✗	✓	✓
Load sensing pressure	[MPa]	✗	✓	✓
Engine torque	[Nm]	✗	✓	✓
Brake pressure	[kPa]	✗	✓	✓
Brake pressure @ >0.5km/h	[kPa]	✗	✓	✓
Engine speed	[rpm]	✗	✓	✓
Engine power	[kW]	✗	✓	✓
Gear	[-]	✗	✓	✓
Lift angle speed	[mrad/s]	✗	✓	✓
Tilt angle speed	[mrad/s]	✗	✓	✓
Lift lever	[%]	✗	✓	✓
Tilt lever	[%]	✗	✓	✓
Lift angle	[mrad]	✗	✓	✓
Tilt angle	[mrad]	✗	✓	✓
Lift angle @ F→R	[mrad]	✗	✓	✗

## 2.4 Empirical Study Output

As a first step in the processing of the empirical study results to be used as input to the theoretical global optimum calculation, the average fuel efficiency and productivity for each operator is calculated. Only the wheel loader cycle is included, the times when the wheel loader is not doing any work is excluded. As a second step, the fuel efficiency and productivity per cycle is calculated. It is worth mentioning the difference between 1<sup>st</sup>, 2<sup>nd</sup> and 3<sup>rd</sup> cycle when filling the hauler as discussed earlier. To favor

consistently high fuel efficient behavior, the operator with the highest average fuel efficiency, that also had a small deviation between the cycles, is chosen, EP15 in this case, and this operator's best cycle, see the green square marker in Fig. 2.14, is used as benchmark to the theoretical global optimum calculated in Chapter 3. These two results, empirical and theoretical, are then compared in Chapter 4. To be able to use a measured cycle as benchmark, the cycle time, turning point and position of hauler and gravel pile are fed into the optimal control algorithm. This corresponds to the "Work cycle optimization" layer in Fig. 1.7. The output from the optimization algorithm is the movement of the three main actuators: lift, tilt and propulsion. This corresponds to the "Actuation optimization" layer in Fig. 1.7.

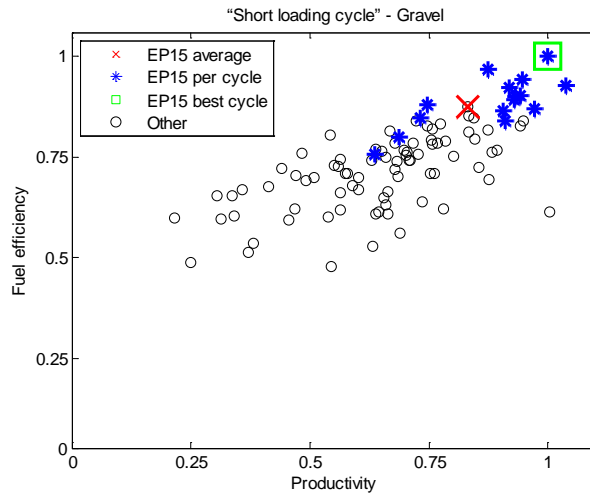

Fig. 2.14 The fuel efficiency and productivity distribution of the most fuel efficient operator, EP15, compared to the other operators' average. Normalized, to the most fuel efficient cycle, due to intellectual properties.

Using the input from the measurements in this way allow the isolation of the "Actuation optimization" layer in Fig. 1.7, and consequently verify that the optimization result returned is a global optimum. The "Work cycle optimization" layer is not targeted here, but rather handled in [53,54,55]. This means that the work cycle parameters, such as turning point, gravel

pile position, load receiver position and height, bucket dump angle and cycle time are set from the measured operator's work cycle.

### **Some Concluding Remarks**

While searching for an empirical optimum to challenge a calculated theoretical global optimum it was quickly realized that an empirical study of this magnitude had many more areas of use. Among other things it proved the difficulties when it comes to the testing of construction machines, such as wheel loaders, in a repetitive way. Both the deviation between different operators and different cycles for one operator became evident. Also the large variance between applications was shown. One outcome was that an empirical operator training tool can be quite useful, even if it is based only on measured empirical data. Important is however that before performing a study like this one really need to have full control of all signals and all variables inside and around the machines to be investigated. If not the results from the study could easily be corrupt.

# Chapter 3

## Theoretical Global Optimum – Modeling and Optimal Control Method

An optimal control method that ensures global optimum, together with the related algorithms and implementation, according to the set requirements, is presented in this chapter together with a model of the wheel loader and the environment. The optimal control method and the model of the wheel loader and its environment have to be able to interact in a way that the computation time is kept reasonable. The model of the wheel loader and its environment, with limitations, are also presented in detail.

### 3.1 System Setup

The concept chosen to demonstrate the methodology presented here is a precursor [65] to the concept wheel loader “LX1” [66], revealed at Volvo Construction Equipment Xploration Forum 2016. In this study the wheel loader is performing a “short loading cycle” in a bucket application, loading crushed material onto a load receiver as a part of a production chain. This is a full series hybrid with all three actuators: propulsion, lift and tilt, decoupled.

The reason for choosing the series hybrid for this study is to determine the theoretical global optimum without limitations set by the machine system’s lack of degrees of freedom. This would be the case if optimizing a conventional wheel loader where driveline, working hydraulics and

combustion engine are coupled, as shown in Chapter 1.1. The comparison between the physical measurements on the complete machine, presented in Chapter 2, and the theoretical global optimum, calculated in this chapter, of different machine concepts is further elaborated in Chapter 4 and Chapter 5.

The series hybrid drivetrain consists of one propulsion electrical machine and a three-speed gearbox without a torque converter. The working hydraulics subsystem is also hybridized in series, where one electrical machine propels one hydraulic pump for each function. In this case, lift and tilt are the hydraulic functions accounted for. The steering is also decoupled, but not accounted for because the steering must always receive the power needed to steer for safety reasons. In addition the energy transferred to the steering function is substantially lower, in the range of 6% of the total energy transferred to the working hydraulics [67]. There are also additional auxiliaries that use the steer pump, e.g. the brakes, which are about 1% of the total energy transferred to the working hydraulics [67], but due to the low energy transfer the simplification of only optimizing lift and tilt are reasonable. Hence, the problem to be solved has three control signals: lift, tilt and propulsion, see the schematic diagram in Fig. 3.1.

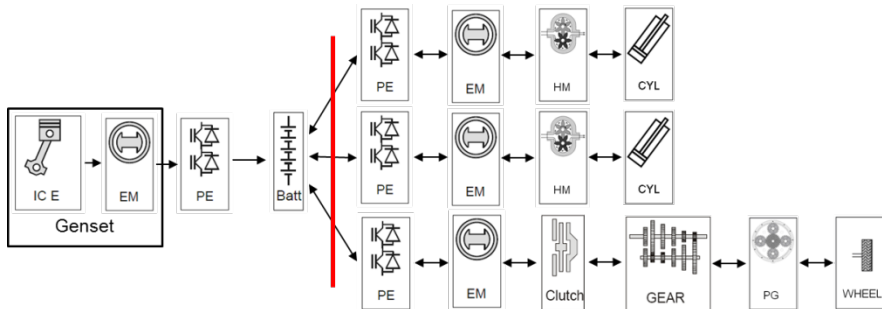

Fig. 3.1 Schematic diagram of the wheel loader concept investigated. *The Genset is the internal combustion engine and electrical machine on the primary energy converter side. ICE is the internal combustion engine, EM is the electrical machine, PE is the power electronics, Batt is the electrical energy storage (battery or super capacitor), HM is the hydraulic machine, CYL is the hydraulic cylinder actuating lift and tilt, Clutch is the clutch in the transmission, GEAR represents the gears in the transmission and PG is planetary gears in the axles and hubs. Modified from on-road vehicles in [68].*



The usage of the primary energy converters and energy storage, shown on the left-hand side, are optimized in a separate optimization. This is to reduce the number of states, thus keeping the optimization within a reasonable computation time. To divide the problem into actuator movement optimization and primary energy conversion optimization, with the actuator movement optimization as input to the primary energy conversion optimization, is a reasonable simplification. This is justified due to the decoupled nature of the series hybrid system. The effect of this simplification should not be too significant on the optimization result [69,70]. The limitations of the total power output from the genset and energy storage system are included in a way such that the sum of the power consumed by the actuators are not allowed to exceed the combined limit of the genset and energy storage. Hence, the prioritization between the actuators is included in the optimization as well.

As discussed in Chapter 1.2, the “Actuation optimization” layer is primarily targeted in the optimal control algorithm, not the “Work cycle optimization” layer. Due to this, the lack of steering does not affect the resulting trajectories of the actuators as long as machine stability is not an issue, however it does significantly reduce the computational time. If machine stability is seen as an issue this can be solved by implementing restrictions on the vehicle velocity with respect to steering angle in conjunction with the height of and load in the bucket. In this case the steering angle has to be either an optimization variable or the path of the wheel loader has to be set with a fix steer angle at each discrete distance step.

### **3.2 Problem Formulation**

The problem to be solved is to find the global optimum regarding fuel efficiency, at a selected productivity, for a given wheel loader concept performing a “short loading cycle” in a gravel application. To keep the machine model as close to reality as possible, quasi-static discrete power loss maps, originating from test rig measurements, are used for all components in the machine. Also the environmental models should be as realistic as possible, therefore the Discrete Element Method, DEM, is used for the gravel pile model. From analysis of the power loss maps and the problem setup, it can be shown that the problem is non-convex. In most of the commonly used optimal control solvers found in literature it would be troublesome to handle these data tables. This is mostly due to the fact that

most of these solvers are gradient based. Thus if the optimization has a machine model that is map based, in practice the gradients can be tedious to calculate. Considering this and the desire to ensure that the global optimum is found, an algorithm based on dynamic programming was developed by the author.

In discrete form the problem can be formulated as:

$$\begin{aligned}
 & \text{minimize} && \sum_{k=0}^{N-1} L(\mathbf{x}_k, \mathbf{u}_k) + \frac{\beta}{x_{k,1}} + E(\mathbf{x}_N) \\
 & \mathbf{x}_0, \mathbf{u}_0, \mathbf{x}_1, \dots, \mathbf{u}_{N-1}, \mathbf{x}_N && \\
 & \text{subject to} && f(\mathbf{x}_k, \mathbf{u}_k) - \mathbf{x}_{k+1} = 0 \text{ for } k = 0, \dots, N-1 \\
 & && \bar{\mathbf{x}}_0 - \mathbf{x}_0 = 0 \\
 & && \bar{\mathbf{x}}_N - \mathbf{x}_N = 0 \\
 & && \bar{x}_{TP,1} - x_{TP,1} = 0
 \end{aligned} \tag{3.1}$$

where  $\mathbf{x}_k$  are the states,  $\mathbf{u}_k$  are the control signals at time  $k$ ;

$$\begin{aligned}
 \mathbf{x}_{k,1} &= \text{vehicle velocity} & \mathbf{u}_{k,1} &= \text{propulsion power} \\
 \mathbf{x}_{k,2} &= \text{lift cylinder position} & \mathbf{u}_{k,2} &= \text{lift cylinder velocity} \\
 \mathbf{x}_{k,3} &= \text{tilt cylinder position} & \mathbf{u}_{k,3} &= \text{tilt cylinder velocity}
 \end{aligned}$$

In  $L(\mathbf{x}_k, \mathbf{u}_k)$  the energy usage per sample, which becomes the power in each sample to minimize, is computed according to the simulation model presented in Chapter 3.5.  $\beta$  is a weighting factor that effects the cycle time by enforcing different average velocity of the wheel loader.  $E(\mathbf{x}_N)$  is the terminal penalty to ensure correct end conditions. In  $f(\mathbf{x}_k, \mathbf{u}_k)$  the states for the next sample are computed according to the simulation model presented in Chapter 3.5.  $\bar{\mathbf{x}}_0$  are the initial conditions and  $\bar{\mathbf{x}}_N$  are the end conditions. The initial and end conditions for all three states are set by the phase boundary conditions as explained in Chapter 3.4.  $\bar{x}_{TP,1}$  is the turning point condition as visualized in Fig. 3.3. The states,  $\mathbf{x}_k$ , and the control signals,  $\mathbf{u}_k$  are discrete sets limited by the physical limits of the components in the wheel loader.

### 3.3 Optimal Control Method

Many optimal control methods are available in the literature, such as [71] and [72]. Over the past few decades, optimal control has become more popular, largely thanks to substantial increase of available computational power, enabling the use of optimal control in more applied

industrial areas. More recent studies that explain different optimal control methods and how to use them in modern computers can be found in [73] and [74].

Different optimization methods can be used to compute a theoretical optimum with regard to fuel efficiency in a vehicle. In [75], an on-road vehicle system optimization problem is investigated by performing a “convexification” of the problem. In [76] the transport part in a wheel loader work cycle is optimized. The optimal control problem solver PROPT [77] is used, which uses a pseudo-spectral collocation method to solve a formulated multi-phase optimal control problem. Here dynamic programming is chosen according to the line of argument in Chapter 3.2.

### Dynamic Programming

Dynamic programming is an optimal control method where an exhaustive search is performed in a structured way [78].

Presuming that the work cycle geographical boundary constraints are set, the focus is then on the “Actuation optimization” level in Fig. 1.7. The optimization problem is to solve how the three actuators, propulsion, lift, and tilt, should behave to optimize the fuel efficiency [ton/l] during the work cycle. This while ensuring that the desired work cycle time is achieved to keep the required productivity [ton/h]. This means that the problem has three control signals,  $\mathbf{u}_{k,1 \text{ to } 3}$  in (3.1). However, for visualization purposes a schematic graph with one control signal is shown in Fig. 3.2.

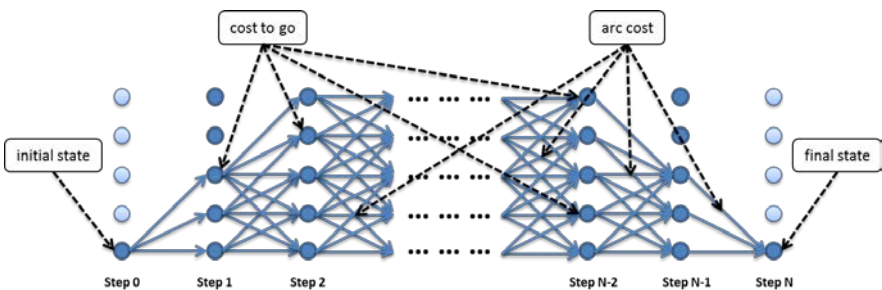

Fig. 3.2 Schematic example of a transition graph for the forward computation with one control signal.

Dynamic programming is a discrete method based on taking a decision at every sample. The basic idea is to, for a known work cycle, compute the cost-to-go backwards in each discrete sample for each discretized state value in a first loop, and in that way get the optimal path. Then the control signals are extracted in a second forward loop, to save memory, with the help of the arc-costs, see Fig. 3.2. The arc-cost is the cost for going from one point to another on the state grid. In this case, this relates to the energy consumed by the wheel loader during that particular step. Interpolation is used between the current cost-to-go and the sum of the previous cost-to-go and the arc-costs to be able to keep a sparse grid to save computational power. In a given work cycle, the actuator movement optimization discretization of the  $x$ -axis is the distance. There are three “ $y$ -axes”: wheel loader velocity, lift cylinder position and tilt cylinder position. These correspond to the state  $\mathbf{x}_{k,1 \text{ to } 3}$  in (3.1). The initial and final machine positions are set in a way such that the wheel loader completes the work cycle. The initial,  $\bar{\mathbf{x}}_0$ , and final,  $\bar{\mathbf{x}}_N$ , states are set according to the boundary conditions given by the geographical boundary imposed on the work cycle. This results in forbidden arc-costs and that is why not all the arrows are visible at the left and right extremes in Fig. 3.2. The control signals  $\mathbf{u}_{k,1 \text{ to } 3}$  in (3.1): the propulsion electrical machine torque, the lift cylinder speed and the tilt cylinder speed all have limitations because the electrical machines have a maximum torque at any given speed which results in a maximum possible acceleration. This is why not all transitions are allowed in the middle of the graph in Fig. 3.2. More about dynamic programming can be found in [78].

### 3.4 Dynamic Programming Implementation

For a given work cycle and a given machine concept, an algorithm is developed to find the global optimum with regard to fuel efficiency [ton/l]. For the actuators, shown here as an example, this is converted to electrical actuator energy efficiency [ton/J]. The work cycle is divided into four phases: “*Loading*”, “*Transport with load*”, “*Unloading*” and “*Transport without load*”, see Fig. 3.3. It is possible to connect the phases together in the optimization tool since the work cycle has a fixed starting point, ① in Fig. 3.3, end point, ③ in Fig. 3.3, and turning point, ② in Fig. 3.3, for the driveline, and start and end points at loading and unloading, ① and ③ in Fig. 3.3, for both lift and tilt position. In the example presented these fixed points are taken from the measurements in Chapter 2.4. The computational

time can be lowered by parallel computing on multiple cores when the four phases are computed in parallel instead of in series. Due to the fixed boundary points, the split does not affect the optimization results. Dividing the problem into a path planning optimization of the work cycle and an actuator movement optimization adds a risk of sub-optimal solutions. However, in many cases, these points are set by outer environmental constraints such as location of the pile, load receiver position and other obstacles. This in turn reduces the degrees of freedom in the path planning optimization but does not affect the actuator movement optimization, as the setup is according to (3.1) without steering, which lowers the risk of sub-optimal solutions.

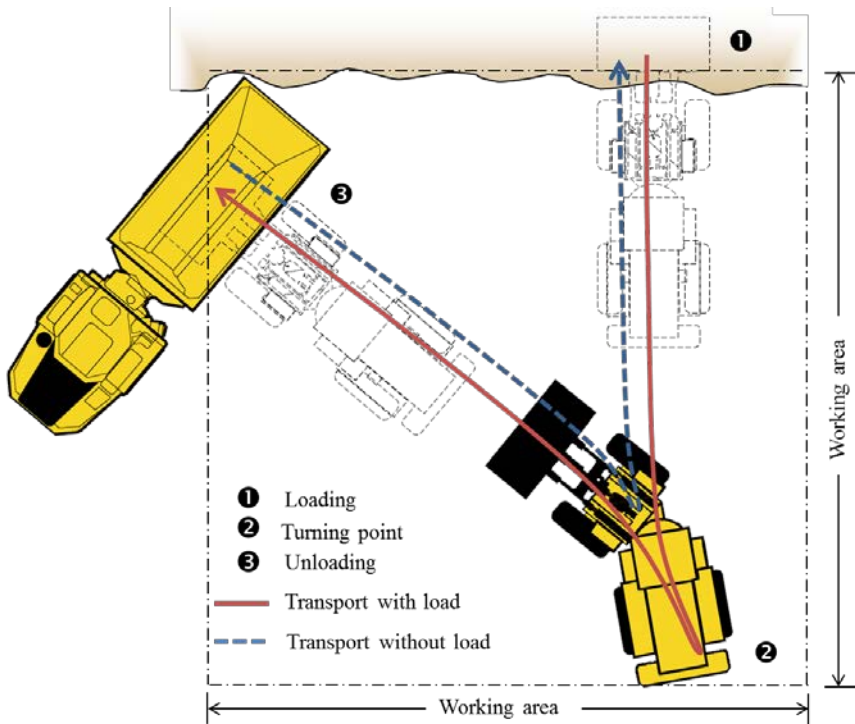

Fig. 3.3 Visualization of the “short loading cycle”, showing the phases and working area, modified from [1].

In dynamic programming, the implementation is a challenge due to the curse of dimensionality [72,78], where the nonlinear relationship between the level of discretization and computation time is clearly exposed.

Optimizations with different levels of discretization, both for the control signals and for the states, were carried out to ensure that the solution is not depending on the level of discretization, see the Convergence subchapter below.

To be able to reach the fixed points in the working cycle, end penalties,  $E(\mathbf{x}_N)$  in (3.1), have to be implemented. These ensure that the wheel loader is moving and energy is used. A weighting factor,  $\beta$  in (3.1) and (3.2), has to be implemented to ensure that the desired work cycle time is achieved to ensure the correct productivity. The algorithm would otherwise prefer to just stand still and not waste any energy if not forced to reach the end points with regard to both lift and tilt position, and to travel the set distance in each phase at the given cycle time.

To simplify the understanding, a pseudocode of the dynamic programming implementation is shown in Fig. 3.4 and Fig. 3.5. The arc-costs are first computed backwards to get the cost-to-go in all points in Fig. 3.2 and ensure correct ending point, see Fig. 3.4.

```

for i=final discretized distance step down to 0
  for j=0 to top discretized machine velocity
    for k=lowest to highest discretized lift position
      for l=lowest to highest discretized tilt position
        Compute the arc-cost according to (3.2).
        Save cost-to-go in each grid point for use in
        Fig. 3.5 by accumulating the minimum arc-cost
        and previous cost-to-go.
      end
    end
  end
end
end

```

Fig. 3.4 Pseudocode for the backward computation of the cost-to-go.

Interpolation of the arc-cost is done to lower the computation time. There is a high out-of-bound penalization factor implemented when calculating the arc-cost to ensure that the algorithm keeps within the boundary conditions of the components. To reduce the discretization level, and hence also the computational time, whilst keeping the accuracy in the optimization a method that computes two steps inside every loop is used.

The algorithm then computes forward, according to the pseudocode in Fig. 3.5, from the correct starting point to find the control signals that result in the global theoretical optimal solution, with regard to energy efficiency of the actuators, at the set productivity. To calculate the

optimum fuel efficiency at different productivity levels  $\beta$  is used to vary the work cycle time.

```

for ii=0 to final discretized distance
  Compute the arc-cost according to (3.2).
  Compute the total cost by adding
  arc-cost and cost-to-go from Fig. 3.4.
  The optimal control signals are derived
  from the minimum total cost.
end

```

Fig. 3.5 Pseudocode for the forward computation, extracting the optimal control signals for the propulsion, lift and tilt.

The arc costs represent the sum of the energy consumption of all actuators in each arc computation and hence each distance step. The calculation of the arc-costs is detailed in Chapter 3.5.

The optimization tool is also designed to be able to investigate the Pareto front that allows optimizing the trade-off between productivity and fuel efficiency [13]. This is accomplished by changing the cycle time penalty,  $\beta$ , and in that way calculating the maximum fuel efficiency [ton/l] for a set of possible cycle times. This essentially corresponds to the productivity [ton/h], given a specific load in the bucket, for the wheel loader. If the site manager knows the Pareto front for all machines and their specific application in the production chain, then the site can be planned with this in mind to optimize the complete site fuel efficiency. When evaluating different concepts the machine trade-off curve, which is the trade-off between fuel efficiency and productivity as discussed in Chapter 2.2, has to be considered. Different concepts can have maximum fuel efficiency at different productivity, and also the characteristics of the maximum fuel efficiency over the productivity range for the specific wheel loader concept can be different. This is important because it is advantageous to have a machine trade-off curve as forgiving as possible to facilitate different operator behavior [13] and different production rates at different customer sites while maintaining high fuel efficiency. More details on multi-objective optimization can be found in [79,80].

### 3.5 Simulation Model

The model of energy usage, represented by the function,  $L(\mathbf{x}_k, \mathbf{u}_k)$  in (3.1), consists of the wheel loader model and the model of its environment.

The main objective of the model is to calculate the power consumption as accurately as possible, since energy efficiency [ton/J] is the main optimization criterion. Production rate is a secondary optimization criterion and is derived from adjusting  $\beta$ , as discussed in Chapter 3.4.

The arc-cost in Fig. 3.4 and Fig. 3.5 is computed according to (3.2):

$$arc\_cost = (P_{prop} + P_{lift} + P_{tilt} + \beta) \cdot \frac{\Delta d}{v_{avg}} \quad (3.2)$$

where  $P_{prop}$  is the propulsion power delivered to the driveline,  $P_{lift}$  is the lift power,  $P_{tilt}$  is the tilt power,  $\beta$  is weighting factor discussed in Chapter 3.4 and  $\frac{\Delta d}{v_{avg}}$  is the time step converted according to (3.3).

$$\Delta t = \frac{\Delta d}{v_{avg}} \quad (3.3)$$

where  $\Delta t$  is the time step,  $v_{avg}$  is the average velocity of the wheel loader in the time step and  $\Delta d$  is the distance travelled in the time step.

The propulsion power is computed according to (3.4).

$$P_{prop} = P_{wheel} + P_{axle\_loss} + P_{gbx\_loss} + P_{eds\_loss} \quad (3.4)$$

where  $P_{wheel}$  is the power exerted on the wheels,  $P_{axle\_loss}$ , calculated in (3.12), is the losses in the axles,  $P_{gbx\_loss}$ , calculated in (3.13), is the gearbox losses and  $P_{eds\_loss}$ , calculated in (3.14), is the losses in the propulsion electric drive system, which include the electrical machine and power electronics. The wheel power is computed from (3.5), (3.6), (3.8) and (3.9).

$$P_{wheel} = T_{wheel} \cdot \omega_{wheel} \quad (3.5)$$

where  $T_{wheel}$  is the torque exerted on the wheels and  $\omega_{wheel}$  is the wheel speed. The wheel torque is computed from

$$T_{wheel} = F_{wheel} \cdot r_{wheel} \quad (3.6)$$



where  $F_{\text{wheel}}$  is the force exerted from the wheels to the ground and  $r_{\text{wheel}}$  is the wheel radius.

In the ‘‘Loading’’ phase in Fig. 3.3, the wheel force and the machine speed are determined in the gravel simulation model, represented by  $f_1$  in (3.7). The gravel simulation model is presented further in the Discrete Element Method, DEM, subchapter below. The bucket trajectory is defined by the forward position,  $x_{\text{bucket}}$ , the upward position,  $y_{\text{bucket}}$  and the angle of the bucket,  $\theta_{\text{bucket}}$ . The bucket trajectory is used as input to the DEM simulation.

$$\begin{aligned} (F_{x\_bucket}, v_{x\_bucket}, F_{z\_bucket}, v_{y\_bucket}, T_{bucket}, \omega_{bucket}) = \\ = f_1(x_{bucket}, y_{bucket}, \theta_{bucket}) \end{aligned} \quad (3.7)$$

The results from the DEM simulations are then post processed via an existing Volvo internal kinematic model of the lifting unit represented by  $f_2$  in (3.8). The kinematic model is used as an ideal model, considering the internal friction in the lifting unit, however the internal friction can be added as a percentage of the load if needed.

$$\begin{aligned} (F_{wheel}, v_{avg}, F_{lift_{cyl}}, v_{lift_{cyl}}, F_{tilt_{cyl}}, v_{tilt_{cyl}}) = \\ = f_2(F_{x\_bucket}, v_{x\_bucket}, F_{z\_bucket}, v_{z\_bucket}, T_{bucket}, \omega_{bucket}) \end{aligned} \quad (3.8)$$

where  $F_{x\_bucket}$  is the horizontal force on the bucket,  $v_{x\_bucket}$  is the horizontal velocity of the bucket,  $F_{z\_bucket}$  is the vertical force on the bucket,  $v_{z\_bucket}$  is the vertical velocity of the bucket,  $T_{bucket}$  is the torque on the bucket and  $\omega_{bucket}$  is the angular velocity of the bucket, see Fig. 3.6.

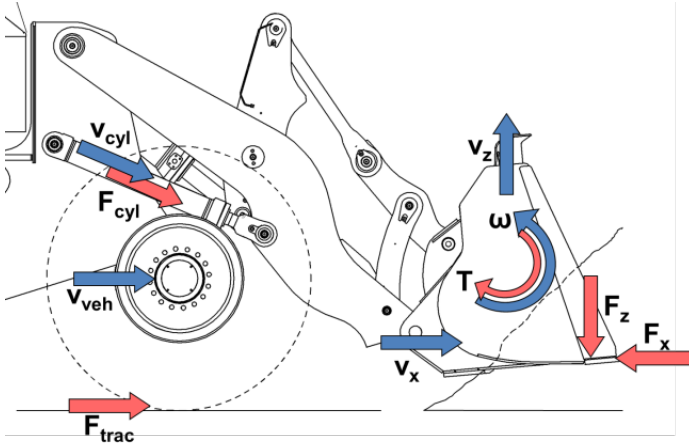

Fig. 3.6 Schematic illustration of the forces and speeds of the bucket and how they translate to cylinder and wheel forces and speeds, modified from [32].

In the rest of the work cycle, “Transport” and “Unload” in Fig. 3.3, the wheel force results in an acceleration force for the machine according to the vehicle motion equation in (3.9) [81].

$$F_{acc} = F_{wheel} - F_{roll} - F_{air} \quad (3.9)$$

where,  $F_{acc}$  is the acceleration force for the machine,  $F_{roll}$  is the rolling resistance and  $F_{air}$  is the air resistance.  $F_{roll}$  is simplified to be constant since in the “short loading cycle” the working area is constrained to a small geographical area according to Fig. 3.3. The acceleration force generates the machine velocity, see (3.10), which is the state variable for the driveline.

If  $v_{final}$  is the end velocity for the discrete step,  $v_{init}$  is the initial velocity,  $m$  is the machine mass and  $\Delta s$  is the step distance, the resulting motion of the wheel loader is computed in (3.10).

$$v_{final} = v_{init} + \frac{F_{acc}}{m} \cdot \frac{\Delta s}{v_{init}} \quad (3.10)$$

The control signal in the driveline, the propulsion electrical machine torque,  $T_{em}$ , is computed in (3.11).

$$T_{em} = \frac{T_{wheel} + \frac{P_{axle\_loss}}{\omega_{axle}} + \frac{P_{gbx\_loss}}{\omega_{gbx}}}{gr_{gbx} \cdot gr_{axle}} \quad (3.11)$$

where  $\omega_{axle}$  and  $\omega_{gbx}$  is the internal angular speed in the axle and gearbox,  $gr_{gbx}$  and  $gr_{axle}$  are the gear ratios in the gearbox and axle. The mechanical losses in the gearbox and axles,  $P_{gbx\_loss}$  and  $P_{axle\_loss}$ , are computed in (3.12) and (3.13).

$$P_{gbx\_loss} = f_3(T_{wheel}, v_{avg}) \quad (3.12)$$

$$P_{axle\_loss} = f_4(T_{wheel}, v_{avg}) \quad (3.13)$$

where  $f_3$  and  $f_4$  are tabulated values from test rig measurements.

The losses in the electric drive system,  $P_{eds\_loss}$ , are computed in (3.14).

$$P_{eds\_loss} = f_5(T_{em}, \omega_{em}) \quad (3.14)$$

where  $\omega_{em}$  is the speed of the propulsion electrical machine and  $f_5$  consists of tabulated values from test rig measurements.

The power to the hydraulic system,  $P_{lift}$  and  $P_{tilt}$  is computed by (3.15) and (3.16).

$$P_{lift} = f_6(F_{lift\_cyl}, v_{lift\_cyl}) \quad (3.15)$$

$$P_{tilt} = f_7(F_{tilt\_cyl}, v_{tilt\_cyl}) \quad (3.16)$$

where  $F_{lift\_cyl}$  and  $F_{tilt\_cyl}$  are the forces and  $v_{lift\_cyl}$  and  $v_{tilt\_cyl}$  are the velocities of the lift and tilt cylinder respectively. These are the control signals for the hydraulic actuators. The functions  $f_6$  and  $f_7$  are tabulated values from test rig measurements.

In the ‘‘Loading’’ phase, see Fig. 3.3, the bucket forces and velocities are calculated in the DEM gravel simulation and then post processed to

cylinder and wheel forces in the Volvo internal kinematic model of the lifting unit, see (3.7) and (3.8). In the rest of the work cycle, the “Transport” and “Unloading” phases, the cylinder forces are calculated in (3.17).

$$(F_{lift\_cyl}, F_{tilt\_cyl}) = f_2(pos_{lift\_cyl}, pos_{tilt\_cyl}) \quad (3.17)$$

where  $pos_{lift\_cyl}$  and  $pos_{tilt\_cyl}$  are the cylinder positions, which are the states for the hydraulic system, and  $f_2$  is the same Volvo internal kinematic model of the lifting unit used in (3.8). Not modeling the dynamics in the lifting unit is considered a reasonable simplification due to that the energy consumption corresponding to the dynamics is in the range of 2-3% of the energy used during a complete work cycle. The percentage is based on comparing the potential energy of the load at dump height compared to the kinetic energy and the energy needed to accelerate the load up to maximum velocity of the load.

The wheel loader model that is described by equations (3.8) and (3.11) to (3.17) is built of quasi-static power loss maps for each component that originate from real test rig measurements. The maps correspond to  $f_2$  to  $f_8$  in the equations and have tabulated values within the physical boundaries for each component. If the optimization algorithm attempts to access a value outside the physical boundaries, a large out-of-bound penalty is provided instead, resulting in an impossible step in the optimization. Maps are an accurate way to model the wheel loader because the true, measured losses, are accounted for and there are good opportunities for analysis of the different subsystems and components. The drawback is that the internal dynamics in each component are not necessarily fully accounted for. All the major components are included. In the driveline: wheels, axles, transmission, electrical machine and power electronics. In the working hydraulics: lifting unit, hydraulic cylinder, hydraulic machine, electrical machine and power electronics. Furthermore, indexed search in the maps enables fast computation.

It is worth highlighting that the forces on the bucket at a given point in a trajectory through the pile are highly dependent on the history of where the bucket has been in past time samples. This means that if dynamic programming is to be used in the “Loading” phase then at each discrete time step, when a decision is to be taken if the bucket should be lifted, tilted or penetrate the pile further, the complete trajectory has to be

recalculated in the DEM gravel pile model. This co-simulation would require too high computational power and computation time. Instead, a selection of trajectories, see Chapter 3.6 where the selection of the trajectories is detailed, is simulated in the DEM gravel pile model and then these already simulated trajectories are used in the dynamic programming framework, in the “*Transport with load*”, “*Unloading*” and “*Transport without load*” phases. The reason for using the dynamic programming framework and not only the selection of trajectories is that the end-positions of the lift and tilt are not the same in all the trajectories resulting in different input to the “*Transport with load*” phase.

### Discrete Element Method

Due to the high importance of the gravel pile model accuracy as discussed in Chapter 1, a DEM model is developed and used by well-known experts in the area, Dr Jan Kleinert and Dr Martin Obermayr, from Fraunhofer ITWM in Kaiserslautern, Germany. The work is presented in [50] and the text is reproduced here for the convenience of the reader.

To compute the arc-cost in the “Loading” phase, consequently the energy, the forces acting on the bucket during loading must be known to get accurate energy estimation. The bucket is modeled as a rigid body interacting with the gravel pile. Many ways for modeling gravel can be seen in literature, often by simplified models that are computationally fast but are not that accurate at calculating the bucket forces [82,83]. An attempt to combine the two methods of “simplified gravel piles” and “Discrete Element Method” can be found in [84], however obtaining the correct forces seems to be a challenge. The decision was made to use the more accurate gravel pile simulation method DEM, Discrete Element Method, that has proven to be a reliable method to model gravel and cohesionless soil [85,86].

In the DEM, the gravel pile consists of discrete particles that interact with each other through a simplified contact law. Two particles are allowed to slightly overlap and a repulsive force,  $F_n$ , proportional to the overlap pushes particles apart according to (3.18).

$$F_n = k_n \cdot \delta_{ij} + d_n \cdot \dot{\delta}_{ij} \quad (3.18)$$

where,  $\delta_{ij}$  is the overlap between two particles indexed by  $i$  and  $j$ .  $k_n$  is the normal stiffness coefficient and  $d_n$  is the damping parameter. It

becomes possible to formulate a scale invariant model by correlating the normal stiffness to the Young's modulus of the material [50,87,88].

As explained in [50], the majority of the draft forces acting on the bucket are caused by inter-particle friction. In the following, the model for Coulomb friction is outlined. Once two particles are in contact the contact points  $x_i$  and  $x_j$  on both particles are stored as well as a contact normal  $n$  that is orthogonal to the surfaces of the two particles. As soon as the particles move, the relative position of the contact points is projected onto a plane orthogonal to  $n$  to obtain the tangential deformation vector,  $\xi_t$ , according to (3.19).

$$\xi_t = \mathbf{n} \cdot (\mathbf{x}_i - \mathbf{x}_j) \quad (3.19)$$

The tangential force  $\mathbf{F}_t$  is computed in

(3.20).

$$\mathbf{F}_t = k_t \cdot \xi_t + d_t \cdot \dot{\xi}_t \quad (3.20)$$

where  $k_t$  and  $d_t$  are the tangential stiffness and damping parameters respectively. If the magnitude of the calculated tangential force is greater than the Coulomb limit  $\mu \cdot F_n$ , the contact is in sliding mode. In this case, the tangential force is clamped to the Coulomb limit, that is  $\mathbf{F}_t = \mu \cdot F_n$ , and the deformation vector is updated according to (3.21).

$$\xi_t^* = \frac{\mu \cdot F_n}{k_t} \cdot \frac{\xi_t}{\|\xi_t\|} \quad (3.21)$$

If  $q_i$  and  $q_j$  are the centers of mass of the two particles respectively,  $x_a = q_i + \frac{r_i}{r_i+r_j} \cdot (q_i+q_j)$  is called the actuation point of the contact. The contact points on the particles are updated to  $x_i = x_a + \frac{\xi_t^*}{2}$  and  $x_j = x_a - \frac{\xi_t^*}{2}$  and stored in the local coordinate systems of the particles for use in the next time step. The tangential force is recalculated accordingly. As a result, the particles are in sliding mode [50].

While DEM allows for many complex contact models, the simple normal and tangential contact models introduced here are sufficient for the

purpose of measuring draft forces in dry gravel [33,86]. Dry gravel is used to be able to relate to the measurements done inside the tent, see Fig. 2.1.

Once the contact forces are known they can be explicitly integrated to obtain the velocities and positions of all particles in the gravel pile. The contact forces resulting from contacts between particles and the bucket of the wheel loader are used to compute the arc-cost of the “Loading” phase.

The simulation setup is identical to the one in [33]. The gravel pile is 5m high, see Fig. 3.7. To save computational cost, a 1m wide slice of the pile is used in the simulation. The forces on the bucket are then corrected via an appropriate weighting factor according to the width of the bucket. Comparisons to a full three dimensional simulation were performed to make sure this is a reasonable simplification. The slice of the gravel pile consists of around 16000 spherical non-rotational particles. Non-rotational spherical particles are chosen in order to save computational effort. The irregularities in shape that are present in a real gravel pile are instead modeled by introducing a rolling resistance in the contact model. In the case of non-rotational spherical particles the rolling resistance is modeled by locking the rotation and account for the roll resistance and slide resistance weighted together by the tangential force in (3.20) instead and parameterized according to that. The material parameters are chosen according to a known material that has previously been parameterized with the help of laboratory tests [50].

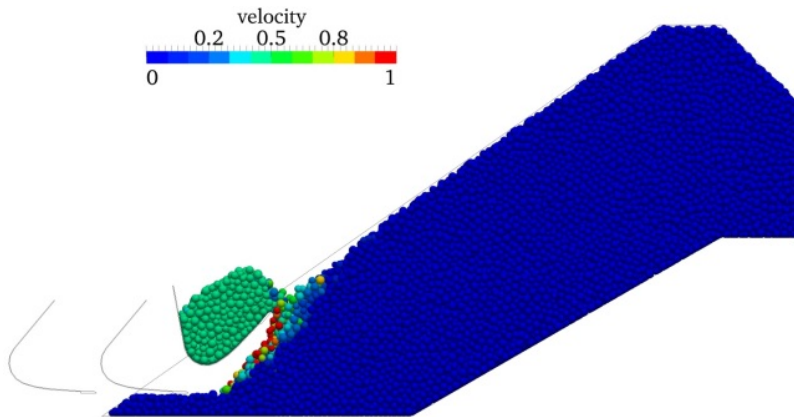

Fig. 3.7 Snapshot of a DEM simulation using a 5m high, 1m wide gravel pile [50].

### 3.6 Trajectory Generation

Ideally the DEM simulation would be part of the overall simulation that includes the optimal control calculations. In this way, both physical properties and optimality would be ensured. However, no traditional optimal control algorithm can be used as the overall problem is not, and cannot be made convex. This in turn precludes the use of gradient descent optimization. Instead the proposed algorithm based on dynamic programming may be used. However, running one big simulation with a complex machine model in a sufficiently detailed environment, controlled by an adaptive operator model is impossible with the calculation resources typically available today, because the computational costs of using dynamic programming would be extraordinary high. This can of course change in the near future, considering cloud computing [63]. Instead, as many trajectories as possible, which are in the viable region where the wheel loader can complete a trajectory, are created. These are simulated in the DEM gravel pile model and the already simulated trajectories are then used in the dynamic programming framework.

Fig. 3.8 shows the simulation process employed: the bucket trajectories, generated in MathCad or Matlab, are transferred as text files to the DEM particle simulation run in Pasimodo, as reported in [33]. The results obtained from DEM are transferred back to MathCad for post processing, for example converting the forces acting on the bucket into cylinder forces and rim pull demand. The results are then either passed on to Matlab and the optimal control algorithm running the wheel loader simulations or kept within MathCad to compute the simple performance indicators published in [37].

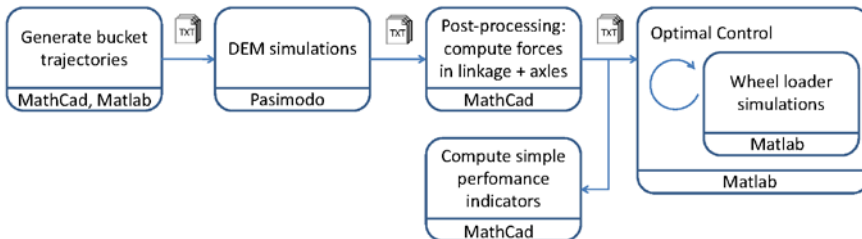

Fig. 3.8 Workflow for calculating the theoretical global optimum, including the trajectory generation process [63].



Two methods have been used to create the trajectories that were simulated in the DEM gravel pile model. First, a set of trajectories were created using recursive programming [89] by discretizing the bucket movement through the gravel pile, with regard to the bucket forward position,  $x_{bucket}$ , the bucket upward position,  $z_{bucket}$  and the angle of the bucket,  $\theta_{bucket}$ , see (3.7). Movements, i.e. changes in one, two or the three positions can be done as one discrete step in each time sample, see the blue trajectories in Fig. 3.9. At the desired discretization level, several hundreds of thousands trajectories would be needed to be simulated in DEM, which is not feasible due to computation time. Instead a lower discretization level is chosen in the recursive programming. More on how to improve this selection is written in [63]. A second set of analytical trajectories are created manually as a complement, see the red trajectories in Fig. 3.9. The analytically created trajectories are motivated by engineering experience of different bucket filling strategies observed from professional operators [33]. The initial pile slope is set to  $35^\circ$ , this corresponds to the angle of repose in typical pre-processed gravel material in a rehandling application. The material has a bulk density of  $1650\text{kg/m}^3$ . All trajectories are simulated in the DEM gravel pile model. Altogether 5781 trajectories were simulated on a cluster of 800 CPU cores, taking one week to calculate.

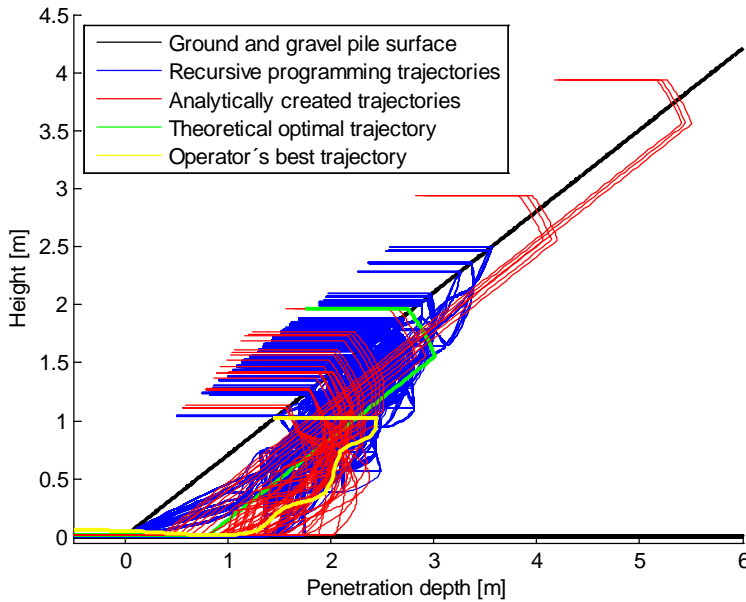

Fig. 3.9 Simulated bucket fill trajectories in DEM. The bucket tip trajectory is drawn. The black lines are the ground level and gravel pile surface. The blue trajectories originate from the recursive programming and the red from the analytic created trajectories. The green trajectory is the theoretical optimal trajectory, calculated in this chapter, and the yellow is the trajectory of the empirically best work cycle in Fig. 2.14.

### 3.7 Holistic Model Overview

An overview on how the complete machine optimization is performed is visualized in Fig. 3.10. “Complete machine optimization” refers to how much primary energy, e.g. diesel in a conventional wheel loader or electricity in a full electric battery machine, is needed when carrying out the optimization in the “Actuation Optimization” layer in Fig. 1.7.

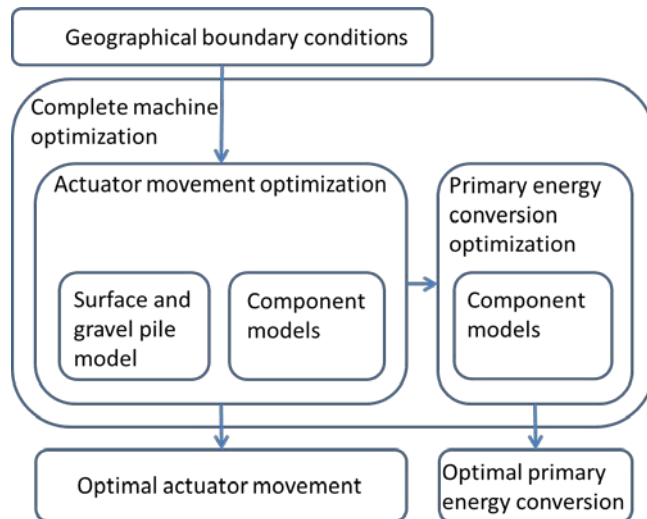

Fig. 3.10 Overview of the model and optimization.

The complete machine is divided into “Actuator movement optimization” and “Primary energy conversion optimization” according to Fig. 3.10. The split is also visible in the schematic diagram of the series hybrid wheel loader in Fig. 3.1. The input to the “Actuator movement optimization” is the “Geographical boundary conditions”, in this case obtained from the measurement from the empirical study presented in Chapter 2.4, see Table 3 for detailed information. The “Actuator movement optimization” is performed by the optimal control algorithm, based on dynamic programming, presented in Chapter 3. In the “Actuator movement optimization” there are a machine model based on the “Component models” and an environmental model of the “Surface and gravel pile model”, as described in detail in Chapter 3.5. The differences between the machine concepts, e.g. that in the series hybrid wheel loader each actuator in the working hydraulics has its own electrical machine and in the conventional and parallel hybrid wheel loader lift and tilt actuator share the same hydraulic pump, are covered in the “Component models”. The output from the “Actuator movement optimization” is the “Optimal actuator movement”, which is used in Chapter 6 as input to the development of operator assist systems, automatic functions and autonomous construction machine control development.

The input to “Primary energy conversion optimization” is derived from the output of the “Actuator movement optimization”. Depending on which machine concept that is being studied, the connection between the “Actuator movement optimization” and the “Primary energy conversion optimization” looks a bit different. In the series hybrid wheel loader it’s the sum of all powers of all actuators. In the conventional machine and the parallel hybrid wheel loader it’s the speed, set by the driveline, and the sum of the torque from the driveline and the hydraulic pump. In the same manner as the “Actuator movement optimization”, the “Primary energy conversion optimization” for the series hybrid and parallel hybrid wheel loader is performed by the optimal control algorithms, based on dynamic programming, presented in Chapter 3. The machine model in the “Primary energy conversion optimization” is also based on “Component models”. The output from the “Primary energy conversion optimization” is the “Optimal primary energy conversion”, which is used in Chapter 5 when performing complete machine concept evaluation and system optimization.

In the optimization the gravel pile model is validated in laboratory conditions, the rolling resistance on a gravel road and all the power loss maps are measured maps from real test rig measurements, hence the model can be seemed as validated. However to validate the model towards complete machine measurements when not all the auxiliary systems are modeled and more important the environmental conditions are unsure and most likely not the same as the one validated on the gravel road and in the laboratory then the uncertainties is larger than the difference between the measurements to be validated against and the results from the simulations, making it an irrational comparison, hence an unreasonable validation.

## **Convergence**

To investigate how the discretization of the control signal affects the optimal control results, different runs with increasing control signal discretization have been performed, visualized by the blue crosses in Table 2. The “Actuator movement optimization” is shown as an example, the analysis of the “Primary energy conversion optimization” looks similar. Only the control signal discretization matters since this sets the resolution in the output power for the three actuators. This in turn results in a motion, either on the driveline or the working hydraulics. The total power of all three actuators with the cycle time weighting factor correspond to the arc-costs in Fig. 3.2.

Table 2 Runs with different levels of discretization.

Run	Control signal discretization	State discretization	Marker
1	11x11x11	11x10x10	X
2	21x21x21	11x10x10	X
3	41x41x41	11x10x10	X
4	61x61x61	11x10x10	X
5	81x81x81	11x10x10	X
1	11x11x11	21x19x19	O
2	21x21x21	21x19x19	O
3	41x41x41	21x19x19	O

As can be seen in Fig. 3.11, represented by the blue crosses, the normalized energy usage is relatively insensitive to control signal discretization increases past “Run” 2”. With further discretization, the solution changes by less than 1%. Therefore this discretization level is used henceforth.

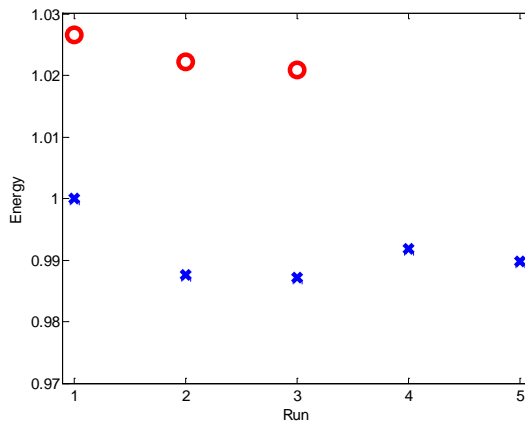

Fig. 3.11 Normalized energy usage for different discretization levels. Legend and level of discretization according to Table 2. Normalized, to the work cycle energy usage of the first run, due to intellectual properties.

To investigate how sensitive the result is to the interpolation between the states, when interpolating from the different arc-costs, three of the simulations were repeated with an increased level of discretization of the

states. The results are represented with red circles in Table 2. and Fig. 3.11. The difference in the results of the two discretization levels is small in comparison to other sources of error, for example the simplified machine and environment model presented in Chapter 3.5. Considering the exponential increase in calculation time with each increasing level of discretization, see Fig. 3.12, there is no practical justification for using a higher level of discretization. However, there are other ways to increase the level of accuracy, for example by using a better interpolation. A two-step calculation, in each sample, is used in the final version which increases the accuracy to within tenth of one percent from the second run, allows using the state discretization level of the first run henceforth.

The calculation times, schematically in the order of hours to days for the different simulations in Table 2, are shown in Fig. 3.12. Here the exponential curse of dimensionality and the importance of keeping the discretization low are clear.

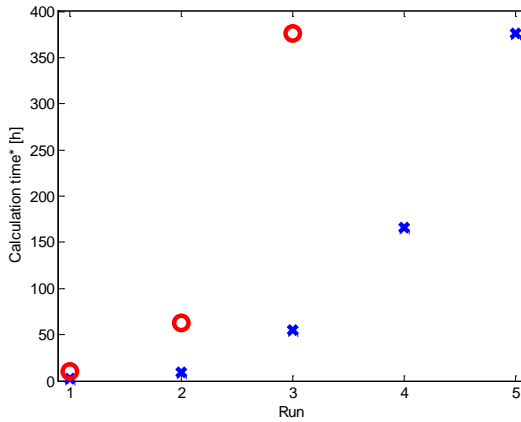

Fig. 3.12 Calculation times for simulations. Legend and level of discretization according to Table 2.

\*On a laptop with a 64-bit Microsoft Windows 7, Intel Core i7-4800MQ @ 2.70GHz quad core CPU and 16GB RAM.

# Chapter 4

## Comparison Analysis

The purpose of this chapter is to make a comparison of empirical fuel efficiency measurements, e.g. the ones in Chapter 2 and customer site measurements, on a real wheel loader, with the corresponding fuel efficiency achieved with optimal control applied as described in Chapter 3. Two cases are studied:

- 1) *Gravel application.* The “short loading cycle”, loading gravel from an artificial stock-pile onto a load receiver, in a typical bucket, rehandling application from Chapter 2 is used as an example.
- 2) *Timber application.* A “short loading cycle”, unloading a truck onto a sorting table, in a typical timber grapple application from a customer site is used as an example.

To utilize the full potential with optimal control of the actuators a full series hybrid wheel loader is used in this comparison analysis. The machine used is a precursor [65] to the concept wheel loader “LX1” [66], revealed at Volvo Construction Equipment Xploration Forum 2016. As shown in Fig. 3.1 and mentioned in Chapter 3.1, the series hybrid wheel loader has a fully decoupled system, where all actuators are decoupled from one another, resulting in that all actuators can be controlled individually. This gives the maximum degrees of freedom of control in the optimal control calculations. In a conventional wheel loader, as discussed in Chapter 1.1 and visualized in Fig. 1.5, all actuators are coupled to one another, either mechanically or hydraulically, resulting in that no actuator can be controlled individually to the full extent. This in turn puts limitations on the theoretical global optimum solution. However, even if some of the coupled nature is visible in the optimal control results for the

conventional and parallel hybrid wheel loaders, the basic shape of the trajectories: vehicle velocity, lift height and tilt angle, are similar to the series hybrid wheel loader, see Fig. 4.1. The reason for the difference in the beginning of the cycle is that another bucket fill trajectory, from Chapter 3.6, comes out as the most fuel efficient in the conventional wheel loader.

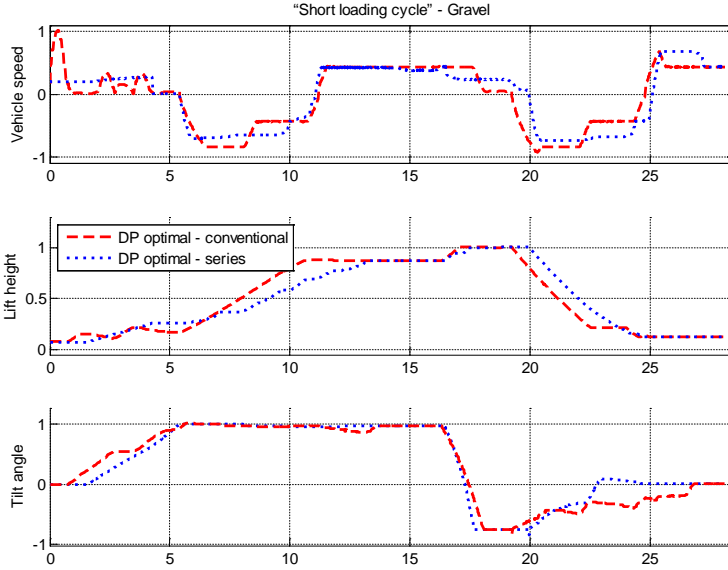

Fig. 4.1 Comparison of the calculated theoretical global optimum trajectories, between the conventional wheel loader and the series hybrid wheel loader.

In Chapter 5 an example is shown on how to use the optimal control based optimization tool in a concept evaluation and system optimization. The theoretical global optimum is calculated for three different machine concepts, conventional, parallel and series hybrid. In addition, the simplification of dividing primary energy converter and actuator movement optimization is not that large when the system is fully decoupled, as in the series hybrid wheel loader. The known limitations when it comes to coupled systems, such as the conventional and parallel hybrid wheel loader [69,70] are further discussed in Chapter 5.



To be able to compare the theoretical global optimum from Chapter 3 to the measurements from Chapter 2 in a fair manner, the fuel efficiency in the measured trajectories has to be computed backwards using the same machine model and environmental model as in the optimal control algorithms in Chapter 3. This means that the measured actuator trajectories are used in conjunction with the simulation model to calculate the energy use. Analyzing the comparison performed between the measured work cycles from the most fuel efficient operators with the optimal control results in Fig. 4.4 and Fig. 4.6 this means that the gravel pile / timber truck, the turning point and the load receiver / sorting table position constitutes the same boundary conditions for both the measured work cycle and the optimal control. In fact these inputs to the optimal control calculation come from the measured cycle, as discussed in Chapter 3. With these geographical boundary conditions in place the optimal control calculates the optimal trajectories of the “Vehicle velocity”, “Lift height” and “Tilt angle” with regard to fuel efficiency, these are compared to the measured trajectories of the “Vehicle velocity”, “Lift height” and “Tilt angle” in Fig. 4.4 and Fig. 4.6.

For the measured work cycle on the conventional wheel loader that are to be compared to the optimal control results, the trajectories of the “Vehicle velocity”, “Lift height” and “Tilt angle” is used as input to the same simulation model presented in Chapter 3, which in turn returns “Energy” and “Power” for the comparison with the calculated optimal control results in Fig. 4.4 and Fig. 4.6. This is due to the fact that not the complete wheel loader, with all of its auxiliaries, frictions, inertias and dynamics are modeled and the large uncertainty of what material and environmental conditions that was present at the measurement comparing the environment and material in the simulation model. This also enables to use the boundary conditions on a measured cycle on a conventional machine concept to be used when evaluating alternative machine concepts. This is to ensure that the calculated global optimum is compared to the measurements with regard to fuel efficiency on the same terms. The reason why fuel efficiency can be used instead of fuel efficiency and productivity in this case is due to the fact that the load and cycle time is the same in the optimal control calculations as in the measurement.

A smaller set of measurements, completed on the full series hybrid wheel loader used in the optimization, is considered as well. This is to ensure a valid comparison between the operators behaviors in the larger

empirical study in Chapter 2, which is performed on a conventional wheel loader, with the full series hybrid wheel loader used in this comparison analysis. The smaller set of measurements was done only with internal professional operators that were performing a handful of work cycles, operating the machine in normal driving pace, according to the denomination in Chapter 2.1. The smaller measurement set indicates similar operator behavior deviation, with regard to fuel efficiency and productivity, but with fewer data points [90,91] which is visualized in Fig. 4.2. On the left, the results from Fig. 2.4 in the large empirical study performed in Chapter 2 on a conventional wheel loader are shown. On the right, the smaller investigation on the series hybrid wheel loader used in the optimal control calculations are shown. Both show the fuel efficiency and productivity deviation between the operators average.

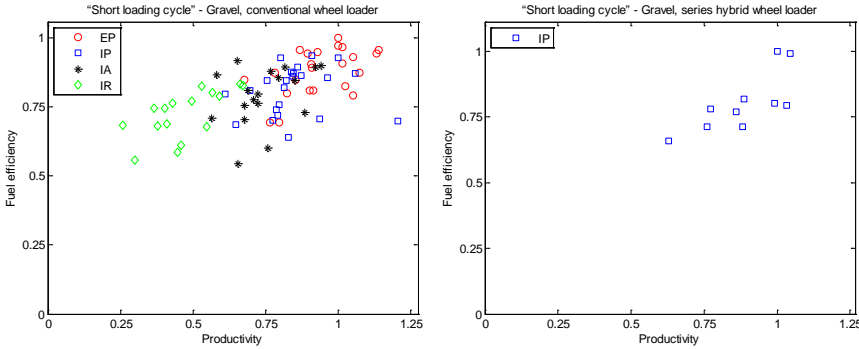

Fig. 4.2 Operator deviation comparison between the operators average. On the left, the conventional machine from Chapter 2. On the right, the series hybrid wheel loader in [65]. As in Fig. 2.1: EP is the external professional, IP is the internal professional, IA is the average and IR is the novice operators. Normalized, to the most fuel efficient operator’s average in each machine concept, due to intellectual properties.

Due to the indication that the operator deviation appears to be similar in the two wheel loader concepts, with regard to fuel efficiency and productivity, and that the available data is much larger in the empirical study in Chapter 2, the data from the larger study is used henceforth when comparing the potential with operator assist, automatic functions and autonomous machine control, e.g. in Chapter 6.

## 4.1 Gravel Application

The cycle used for comparison is a “short loading cycle”, loading re-handled gravel in a bucket application, as shown in Fig. 4.3 and described in Chapter 1 and Chapter 2. The simulation model from Chapter 3.5 is used to calculate the power needed in the measured trajectories. The optimal control trajectories are calculated with the algorithms described in Chapter 3.4.



Fig. 4.3 Measurement setup; loading gravel onto a load receiver in a “short loading cycle”. From Fig. 2.1 in Chapter 2.

The same geographical boundary conditions are valid in both the measured work cycle, which is the most fuel efficient cycle found empirically in Chapter 2, and the resulting trajectory from the optimal control calculations done in Chapter 3, see Table 3.

Table 3 Geographical boundary conditions imposed on the optimal control calculations in Chapter 3, set from the measurements of most fuel efficient operator in Fig. 2.14 in Chapter 2, in the comparison analysis. The wheel loader is loading gravel onto a load receiver in a “short loading cycle”, according to Fig. 4.3.

<b>Geographical boundary conditions</b>	
Angle of repose	35°
Material, pre-processed	1650kg/m <sup>3</sup>
Roll resistance	3%
Pile entry height (bucket tip)	0m
Pile entry angle	0°
Rollback angle (carrying position)	52°
Transport with load	15m
Turning point	9m
Unload height	3.4m
Final unload angle	-46°
Transport without load	13.5m
Turning point	9m

The optimal control algorithm, based on dynamic programming, successfully works in a complete work cycle in a gravel application. The result shows 14% better fuel efficiency in a gravel application, see Fig. 4.3, compared to the best work cycle of the operator that had the best average fuel efficiency that could be found empirically, see Fig. 2.14. The best measured work cycle is approximately 30% better than the average in the measurement. The cycle time is slightly longer, however the difference is very small, around 2% - as can be seen in Fig. 4.4, hence the optimization results are considered to be valid. The trajectories for the three actuators: propulsion, lift and tilt, in the complete work cycle comparison are shown in Fig. 4.4 together with the accumulated energy. The operator trajectories are shown in dashed blue and the theoretical global optimal control result in solid black.

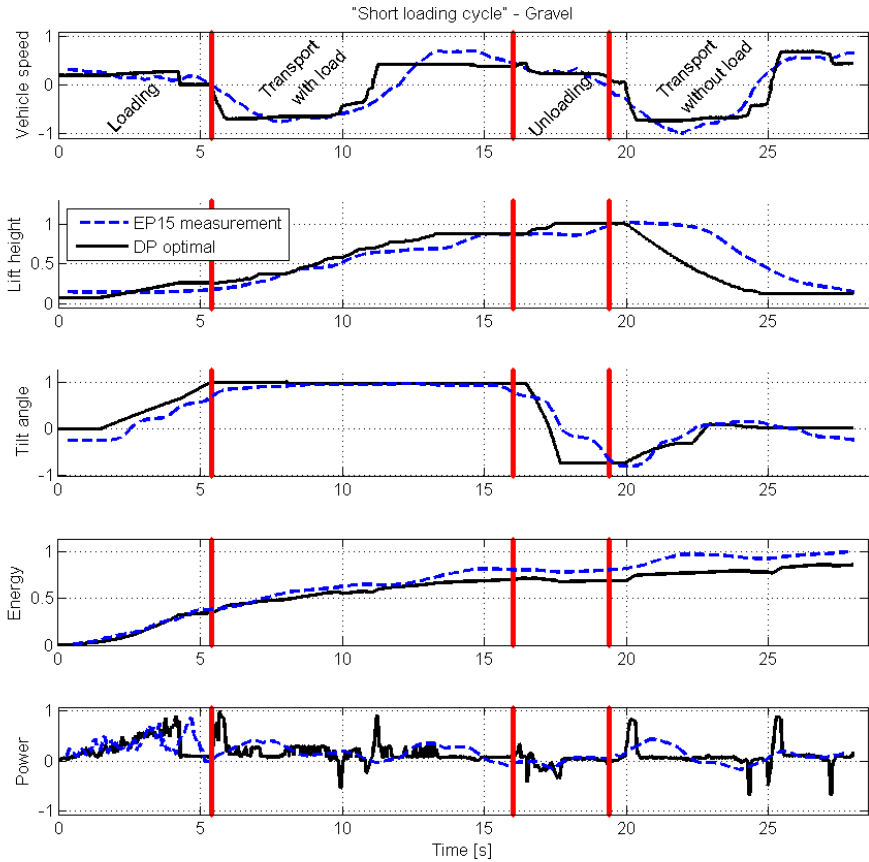

Fig. 4.4 Actuator comparison between the most fuel efficient measured cycle, from the operator with the highest average fuel efficiency in Fig. 2.14, dashed blue line, and the optimal control solution, solid black line. Normalized, to the highest or lowest utilized speed, position, energy and power, due to intellectual properties.

The small differences in initial vehicle speed, hinge pin height and attachment angle in Fig. 4.4 is due to the simulation setup of the gravel pile simulations, where all trajectories had the same initial values, as discussed in Chapter 3.6. The final vehicle speed, hinge pin height and attachment angle is adjusted to have the same offset as the initial values.

The 14% fuel efficiency gain, in Fig. 4.4, is distributed throughout the cycle as shown in Table 4. The energy used by the operator and the optimal control algorithm is compared in each phase to find the energy saving contribution per phase.

Table 4 Fuel efficiency gain in each phase, and the fuel efficiency gain distribution per phase for the complete work cycle in Fig. 4.4.

	Efficiency gain	Efficiency gain distribution
<i>Loading</i>	10%	28%
<i>Transport with load</i>	15%	44%
<i>Unloading</i>	79%	9%
<i>Transport without load</i>	14%	19%
<i>Complete work cycle</i>	14%	100%

In the *Loading phase*, the theoretical optimal solution slices through the pile, needing less energy than the empirical best, see Fig. 4.4. In the *Transport phases*, the majority of the savings comes from hard acceleration and deceleration and keeping low constant speed longer rather than accelerating and decelerating slowly during the complete transport, see Fig. 4.4. This allows better operating points for the components. The gain is higher in the *Transport with load* due to higher gross machine mass and simultaneous lifting, where a higher power output flows in parallel to two different actuators as visualized in Fig. 1.5. In the *Unloading phase*, the reasons are similar to the *Transport phases*, however with more focus on the tilt out function. The actuators, mostly tilt in this case, are used closer to the optimum working point, which in this case means tilting at higher constant speed.

How the fuel efficiency gain distribution looks like is highly dependent on the application, the work cycle layout and the operator behavior. This is evident when comparing the results in Table 4 with the results in Fig. 2.10. In Table 4, where the best work cycle for the operator with highest average fuel efficiency that was found empirically in the study in Chapter 2 is compared to the optimal control results, i.e. the theoretical global optimum, according to the methodology in Chapter 3. The outcome is that the transport phase with load has the highest fuel efficiency gain potential, while when comparing all the operators in the empirical study in Chapter 2, the statement is, considering Fig. 2.10, that the highest fuel efficiency

gain potential is in the bucket fill phase. The reason for this is that the operator that is compared with the global optimum is very proficient and already has a very good bucket filling strategy. If the comparison would have been to midrange operators the bucket fill phase would have a greater impact, see Chapter 6.

## 4.2 Timber Application

A timber grapple cycle from a customer site is used as another example, see Fig. 4.5, to demonstrate that the optimization tool also works in a different application.



Fig. 4.5 A wheel loader with grapple, unloading timber from a truck to a sorting table.

In Fig. 4.5, the wheel loader operator unloads timber from a truck. The work cycle starts by unloading from the truck to then continue by travelling backwards until the closest point where the wheel loader is able to turn. Subsequently forward gear is engaged and the wheel loader travels forward to the sorting table to empty the load. The cycle is completed when the wheel loader travels back to the truck in the reverse order. The work cycle is then repeated until the truck is completely unloaded, when the next truck comes the work task starts all over again.

The same geographical boundary conditions are valid in both the measured work cycle, which is the most fuel efficient cycle found on the

customer site, and the resulting trajectory from the optimal control calculations done in Chapter 3, see Table 5.

Table 5 Geographical boundary conditions imposed on the optimal control calculations in Chapter 3, set from the measurements of most fuel efficient operator on the customer site, in the comparison analysis. The wheel loader is unloading timber from a truck to a sorting table, according to Fig. 4.5.

<b>Geographical boundary conditions</b>	
Roll resistance	3%
Initial load height	3.8m
Initial load angle	-25°
Rollback angle (carrying position)	>0°
Transport with load	63m
Turning point	35m
Unload height	2.8m
Unload angle	-16°
Transport without load	55m
Turning point	26m

In Fig. 4.6, a comparison is shown between the measured operator actuator movement and the optimal control results. The optimal control shows how the actuator movements should be done to achieve maximum fuel efficiency for the specified productivity.



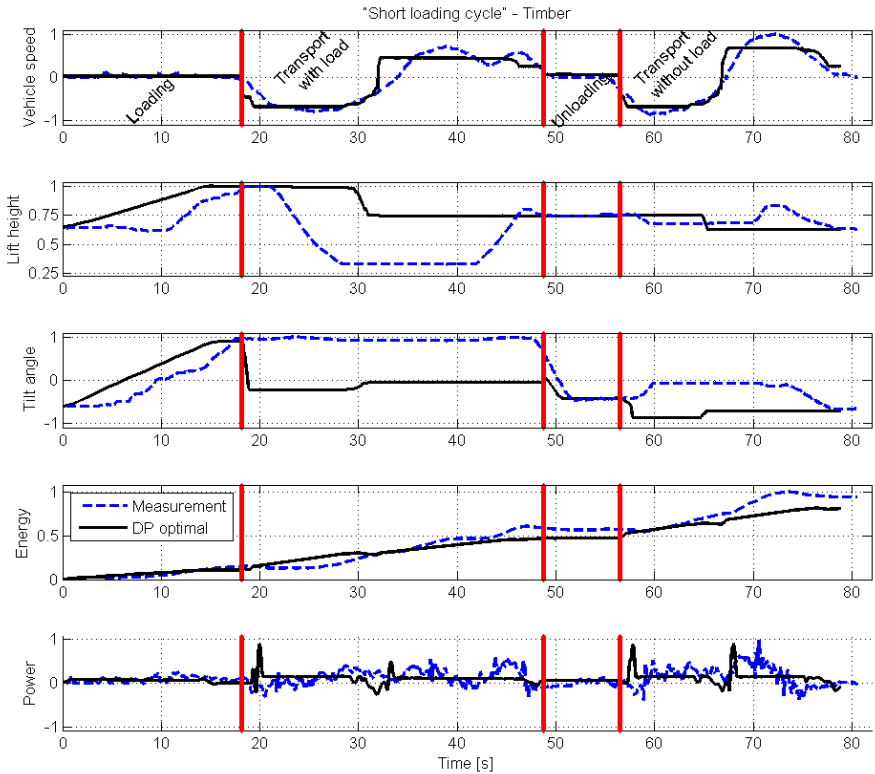

Fig. 4.6 Actuator comparison between the most fuel efficient measured cycle, from a customer measurement, dashed blue line, and the optimal control solution, solid black line. Normalized, to the highest or lowest utilized speed, position, energy and power, due to intellectual properties.

In the timber grapple application, where the wheel loader unloads a truck, the optimal control solution shows 14% higher fuel efficiency comparing to the most experienced operator at one customer site. However, as long as there is an operator in the machine the full potential cannot be reached since some of the maneuvers that consumes energy, for example the lowering of the boom at 28-42 seconds in Fig. 4.6 is due to that the operator wants to achieve higher visibility, although this does not account for the full fuel saving potential. If recalculating, aided by the results shown in Fig. 4.6 and the model presented in Chapter 3.5, and adding the maneuver for visibility reasons, the potential is approximately

12% higher fuel efficiency, depending on the complete machine concept. If the wheel loader is fully autonomous the potential is 14%. This can also be valid if the operator is still in the cab and has an automatic function that is fully trusted available. More about opportunities and limitations in Chapter 6.

### **4.3 Simple Performance Indicators vs. Optimal Control**

In [63] a study on finding the optimal bucket filling strategy is performed for pre-processed gravel material. The analytic trajectories in Chapter 3.6 are presented more in detail and simple performance indicators are compared to optimal control results for a complete work cycle. Also a comparison to a selection of the physical measurements, from Chapter 2 is performed.

In Fig. 4.7 a comparison between the most comprehensive simple performance indicators created, where potential energy and remaining transport were accounted for, and the optimal control results of a complete work cycle are shown. Analyzing the results, and comparing the two graphs in Fig. 4.7, the results differ quite a lot. The easiest way to see that is to analyze how the analytical trajectories change in relation to the greater mass of the recursive programming trajectories, but even the larger mass changes in shape quite a bit. When tracking individual trajectories and comparing them to each other, the results, in respect to which bucket fill trajectory that results in the most fuel efficient complete work cycle, do not come out the same in the two methods either. Notice as well that in the lower graph in Fig. 4.7, where optimal control of a complete work cycle is performed with the algorithms and models presented in Chapter 3, some of the trajectories are not there - especially in the upper left corner, visible in the upper graph. This is because they exceed the performance envelope of the components that are more accurately modeled in the optimal control version compared to the simple performance indicator calculation that does not include the complete machine simulation.

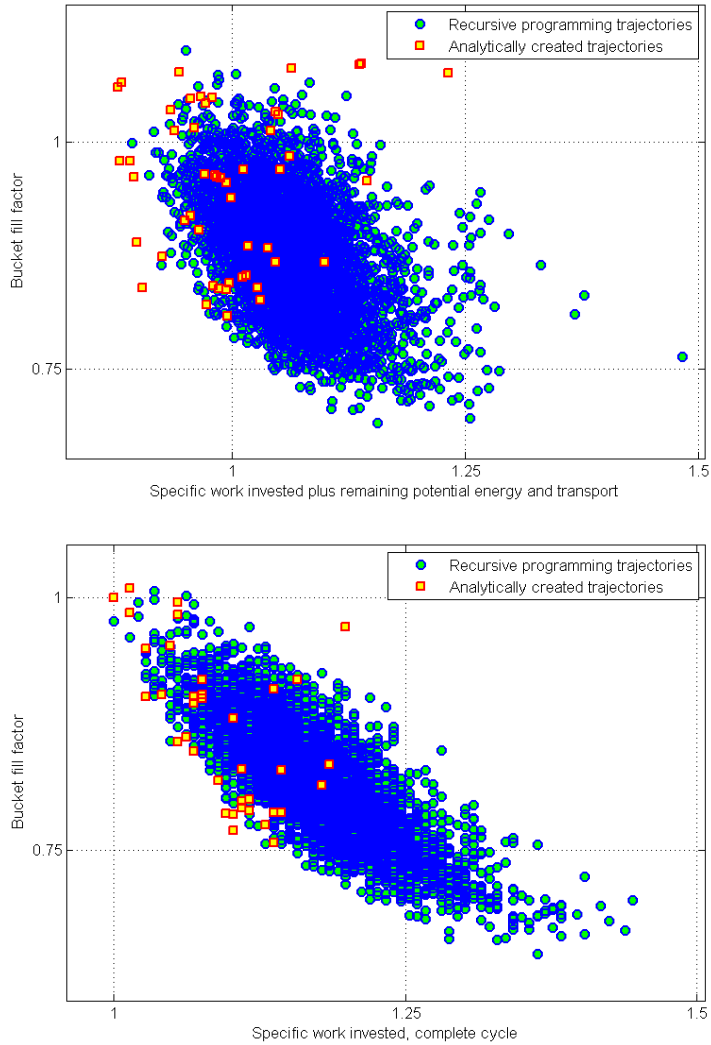

Fig. 4.7 Simulation results on the work invested per ton material loaded. Bucket fill factor for comparison purposes on the x-axis. Upper graph: Simple performance indicators. Lower graph: optimal control on complete work cycle. The analytically created trajectories and the recursive programming trajectories are the same as the ones shown in Fig. 3.9. Normalized, to the trajectory with lowest specific work invested and highest bucket fill factor from the optimal control calculations, due to intellectual properties. Modified from [63].

When there is such a difference between the results of the simple performance indicator calculations and the optimal control calculations, and knowing that the optimal control algorithm ensures global optimum, it can be concluded that when evaluating optimal bucket fill strategy simple performance indicators are not sufficient. A complete machine, complete work cycle optimization that ensures global optimum should be performed to ensure meaningful results.

## Chapter 5

# Concept Evaluation and System Optimization

In this chapter, the optimization tool developed in Chapter 3 is used to perform unbiased virtual concept evaluations with respect to the fuel efficiency potential that depends exclusively on parameters set by the machine concept. Parameters that are not influenced by the machine concept, but still effect the results if the concept evaluation is performed in a more traditional way with backward calculation or forward simulation, include: the control engineer experience and competence, the operator model, and the measured operating cycle data it is forced to follow. The measured cycle in turn depends on another machine concept operated by a certain operator that has limitations as well. These ideas are discussed thoroughly in Chapter 1.

Different machine concepts have different operational “sweet spots” with regard to fuel efficiency, requiring that the global optimum has to be calculated for each concept to secure a fair and objective concept evaluation. A system optimization has to be performed for all major components in each concept to ensure that the global optimum is found. This is to make certain that the comparison is performed with the optimal component power ratings for each concept.

The basic idea is to calculate the theoretical global optimum for each wheel loader concept to ensure the absolute highest fuel efficiency potential for a selected productivity. However, to estimate how much of that fuel efficiency potential that is possible to reach, and to what development effort and cost, an engineering assessment must be done.

With the evaluation tool suggested, based on the optimization tool developed in Chapter 3, an unbiased evaluation method is performed which depends only on the machine concept and its components.

A major positive side effect is that system optimization of each concept, i.e. sizing of the power rating of each major component in the machine can be done within the same optimization tool. However, extreme load cases have to be considered as well, which often are critical for sizing of the components.

There are many factors that need to be accounted for when selecting the best diesel-electric hybrid wheel loader to develop. The most important parameter for the end customers is the total cost of ownership, meaning the cost per ton of material moved in any specific application. This cost can be broken down into purchasing price of the machine, service cost, operator cost and fuel cost, all with productivity as a boundary condition to be able to achieve the set annually production of the site. In this example, the focus is on fuel efficiency, to get as low fuel cost as possible while fulfilling the desired productivity. The cost of the components for each machine concept, the research and development time, and the cost required to industrialize each concept, have to be taken into account in additional calculations.

A small concept evaluation of different diesel-electric hybrid wheel loader concepts is shown as an example. However, the optimization tool is not limited to diesel-electric concepts and can just as well be used for diesel-hydraulic hybrid concepts, full electric machines, and different transmission topologies such as: converter with or without lockup, hydrostatic or continuous variable transmission, etc. The evaluation tool is however most powerful when the concepts to be evaluated are far from the machines in series production, available in the market today. This is due to the fact that the conventional machines, which are in production currently, have large investments in development time and resources, resulting in the possibility of only small incremental improvements over time. In addition, if a similar concept is to be developed, there is a higher probability that the complete machine control code is accurate enough and the concept can be tested in the same manner as the conventional case. In a completely new machine concept, this probability is not as high, resulting in a potentially less effective complete machine control strategy that can further on provide misleading results from a fuel efficiency potential estimation perspective.

## 5.1 Concept Evaluation System Setup

The first task is to define a selection of possible machine concepts on which to investigate which diesel-electric hybrid wheel loader is the most fuel efficient. The design engineer working with wheel loaders must consider a two-dimensional matrix instead of the three basic types of hybrids; parallel, series and complex (power-split) that can be analyzed in the on-road vehicle [34]. This is due to the working hydraulics that adds a degree of freedom with respect to hybridization. Each of the three basic hybrid concepts can be applied to the drivetrain, the working hydraulics or both. If considering diesel-electric hybrids only, this result in a matrix, which can be illustrated as in Fig. 5.1.

Similar to on-road vehicles, each cell in the matrix consists of several concepts. For example, furthest down in the right corner, the concept with series hybrid drivetrain and hydraulics, it can be implemented as one central propulsion electrical machine, two axle-mounted electrical machines or four hub-mounted electrical machines, and each of these three concepts can have different gearbox layouts. In addition to this, these machine setups can have a variety of different working hydraulic systems. For example, but not limited to, conventional load sensing or open center system with a main control valve and with an electrical machine that drives the hydraulic machine, or a pump controlled system, either with one pump and one electrical machine per function or with a flow-sharing valve. Another interesting hydraulic system setup is to use digital hydraulic valves in conjunction with multi-chamber cylinders and high and low pressure accumulators as energy storage [92]. This in turn results in a vast variety of concepts, even at a high level.

In addition to this, a complete system optimization not only encompasses component power rating but also component type. The selection of super-capacitor versus batteries for energy storage is one example, which in turn can be divided in a range of different chemistries. The selection of electrical machine is another example, which can be: internal or surface mounted permanent magnet, induction, or switched reluctance electrical machine. Different hydraulic pump concepts can also be considered such as: in-line or bent axis. Also different transmission concepts can be covered, such as: conventional converter, with or without lock-up, dual clutch, continuous variable transmission, etc. to mention some of the major components. In addition to this, all conventional components such as lifting unit, frame design etc. can be varied as well.

Also the primary energy converter can be composed of a range of different concepts, such as conventional combustion engine, diesel, gasoline or natural gas, fuel cell or full electric battery powered machine.

Three different machine concepts are chosen to demonstrate the evaluation tool, based on the optimization tool developed in Chapter 3. To investigate all different concepts would take a tremendous amount of time, as indicated earlier. The developed evaluation tool is designed to work in a way that an engineering assessment is first done to evaluate the most interesting concepts. These are typically not more than around a dozen concepts due to the effort needed to model and optimize each concept.

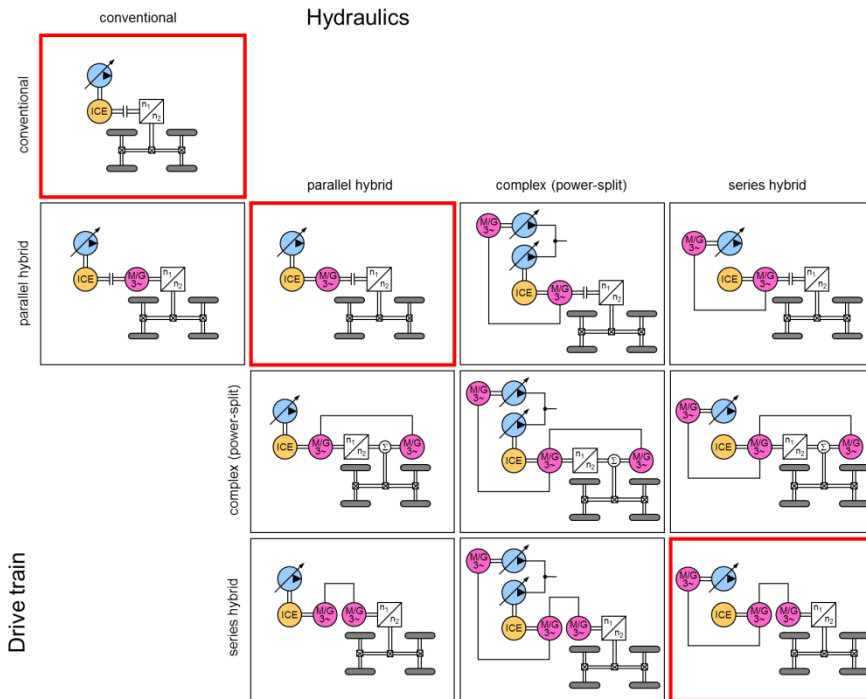

Fig. 5.1 The two-dimensional matrix with the combinations of diesel-electric hybrid wheel loaders, modified from [34].

The three concepts chosen to demonstrate the evaluation tool, based on the optimization tool developed in Chapter 3, are highlighted with red frames in Fig. 5.1: the *conventional wheel loader*, that is in production



right now act as base line; a *parallel hybrid wheel loader* concept, that was shown at ConExpo 2008 [93] and a *series hybrid wheel loader* concept, which is the precursor [65] to the one revealed, at Volvo Construction Equipment Xploration Forum 2016, the concept wheel loader “LX1” [66].

The three different wheel loader concepts are modeled as shown in the schematic diagrams in Fig. 5.2. The main actuators, propulsion, lift and tilt are visible together with the main primary energy converter, the internal combustion engine and in the case of the hybrid concepts, electrical machine and electrical energy storage system as well. The steering is not included in the optimization due to the fact that it always gets the power needed to steer for safety reasons. In addition the energy transferred to the steering function is substantially lower, in the range of 6% of the total energy transferred to the working hydraulics [67]. There are also additional auxiliaries that use the steer pump, e.g. the brakes, which are about 1% of the total energy transferred to the working hydraulics [67]. However, due to the low energy transfer the simplification of only optimizing lift and tilt is reasonable. The simulation model, both for the machine and environment, is described in detail in Chapter 3.5.

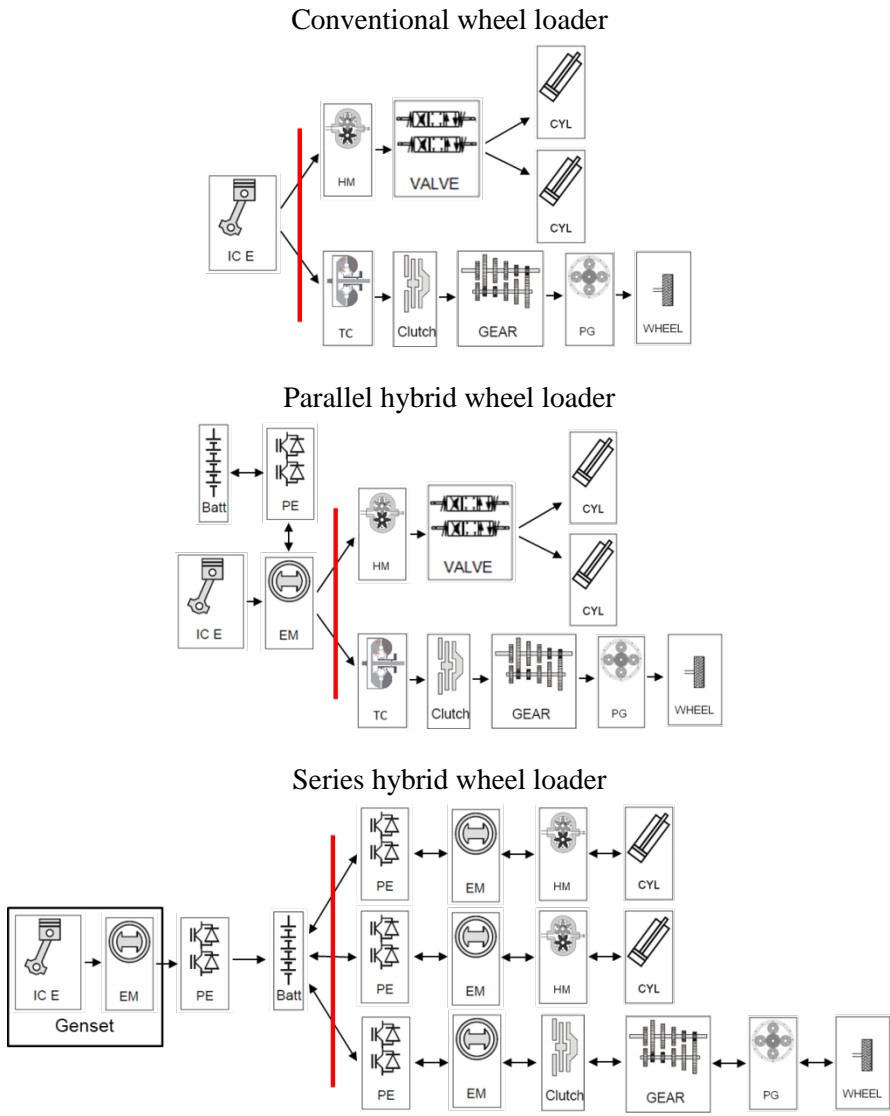

Fig. 5.2. A schematic overview of the three wheel loader concepts evaluated. The red line divides the primary energy converter side and the actuator side in the wheel loader. The Genset is the internal combustion engine and electrical machine on the primary energy converter side in the series hybrid wheel loader. ICE is the internal combustion engine, EM is the electrical machine, PE is the power electronics, Batt is the

*electrical energy storage (battery or super capacitor), HM is the hydraulic machine, VALVE is the hydraulic main control valve, which splits the hydraulic flow between all the hydraulic functions, CYL is the hydraulic cylinder actuating lift and tilt, TC is the torque converter, Clutch is the clutch in the transmission, GEAR represents the gears in the transmission and PG is planetary gears in the axles and hubs. Modified from on-road vehicles in [68].*

### **Concept System Setup**

The main components of the three machine concepts are sized in line with the sizes in the conventional wheel loader as follow;

The *conventional wheel loader*, described in Chapter 1, has a conventional combustion engine that is coupled to the wheels through a torque converter, a four speed gearbox with forward and reverse and conventional axles with a fixed gear ratio. There are also hydraulic machines coupled to the combustion engine that drives the working hydraulics through a main control valve that distributes the hydraulic flow to the actuators.

The *parallel hybrid wheel loader* has the same components as the conventional wheel loader with the exception that a permanent magnet electrical machine is connected to the flywheel of the combustion engine. The electrical machine is approximately one quarter of the combustion engine power rating. The energy storage system is a super capacitor bank of the same power and energy rating as in the series hybrid wheel loader.

The *series hybrid wheel loader*, briefly described in Chapter 3.1, is a full series hybrid wheel loader where all subsystems are fully decoupled. The combustion engine is only connected to an electrical machine to generate electrical power, the power rating is similar as the internal combustion engine in the conventional wheel loader. The drivetrain consists of an identical electrical machine as the generator, connected to a three speed transmission without forward and reverse and without torque converter. In the working hydraulics, each actuator has an electrical machine and hydraulic machine that provides the hydraulic flow; hence no main control valve is present. Each hydraulic machine is almost as big as the main pump in the conventional wheel loader to be able to provide the required actuator speed, which is proportional to the hydraulic flow. The energy storage system is a super capacitor bank of the same power and energy rating as in the parallel hybrid wheel loader.

These three fundamentally different wheel loaders are run through a “short loading cycle” where the optimal control algorithms presented in Chapter 3 ensure maximum possible fuel efficiency for each concept, at the same productivity, which enables unbiased comparison between the three wheel loader concepts. All three machine concepts are modeled according to the same principle, as described in detail in Chapter 3.

## 5.2 Results

The most important result is that the proposed method and the algorithms developed work for all the three investigated machine concepts and furthermore enabling an unbiased concept evaluation and system optimization.

### Concept Evaluation

The results from the concept comparison example between the conventional, the parallel hybrid and the series hybrid wheel loaders are visualized in Fig. 5.3. The parallel hybrid has about 5% higher fuel efficiency [ton/l] and the series hybrid wheel loader has around 23% higher fuel efficiency compared to the conventional machine, which is used as baseline, at the same productivity [ton/h]. The concept evaluation results are shown in Fig. 5.3 with the original component power rating settings, before the system optimization. All three concepts have equivalent power ratings for all actuators and the same power rating of the internal combustion engine. The flywheel mounted electrical machine in the parallel hybrid is one quarter of the power rating of the electrical machine in the genset in the series hybrid.

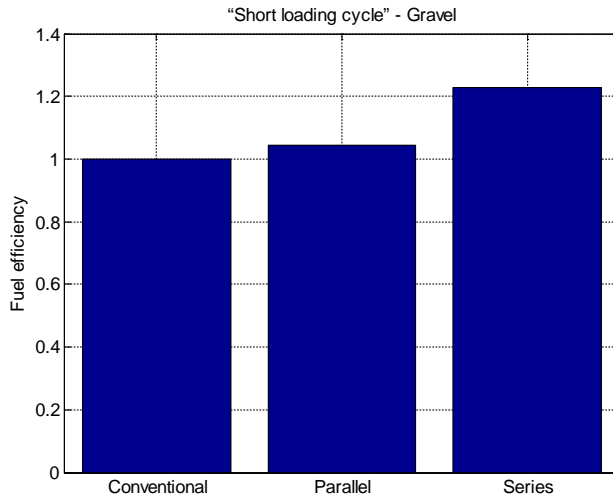

Fig. 5.3. Concept evaluation results for the three concepts evaluated. The conventional wheel loader is baseline, higher fuel efficiency is better. Normalized values, to the conventional wheel loader, due to intellectual properties.

The superior fuel efficiency of the series hybrid, as seen in Fig. 5.3 , might be surprising for an engineer working with on-road applications where the transport of the load is only in one direction with one main power flow going from the combustion engine to the wheels. However, this is not the case with the wheel loader, as discussed in Chapter 1.1, where the power flow is divided in two parallel paths, one to the driveline and one to the working hydraulics. The main contributor to the energy saving is the decoupling of the system in the wheel loader, and not the regenerative braking energy as in most on-road applications. In addition, when comparing to measurements, the known limitations when it comes to coupled systems, such as the conventional and parallel hybrid wheel loader [69,70] are confirmed. The split of primary energy converter and actuators favor conventional and parallel hybrid, in the fuel efficiency potential results from the optimal control calculations, to a slighter extent.

## System Optimization

In this chapter an example of a system optimization is shown. The series hybrid wheel loader is targeted due to its superior fuel efficiency potential. The subsystem chosen to demonstrate the system optimization is the genset in the series hybrid wheel loader. This is due to that the power rating of the components on the actuator side are already set as low as possible when considering complete machine performance requirements. The system optimization could of course be done anyway with increased power rating, however this is seldom economically defensible when considering product cost. Complete machine performance requirements can be for example, but not limited to: speed of the actuators, rimpull, gradeability, lifting power, severity of work cycle that should be possible to performed with charge sustaining, etc.. The system optimization is performed by varying the selected component or subsystem size, and calculating the global fuel efficiency optimum, according to the methodology described in Chapter 3 and used in the concept evaluation above, for each size.

In Fig. 5.4, an example of the results from the system optimization for the genset, the internal combustion engine and the electrical machine, in the series hybrid in Fig. 5.2, is shown. The difference between the largest genset power rating and the optimal power rating is approximately 6% higher fuel efficiency [ton/l], at the same productivity [ton/h], for the optimal genset power rating. Results show that the optimal power rating of the genset in this application is 0.6 times the originally selected maximum genset power rating, equivalent to the power rating of the internal combustion engine in the conventional wheel loader. Even if the power rating factor 0.5 has higher fuel efficiency that is not allowed due to complete machine performance requirements, see Fig. 5.4. In this case this is due to other applications which have a higher average power. A series hybrid with a genset power rating factor 0.5 would deplete the energy storage and then be forced to operate in a derated mode, resulting in loss of production, and hence also money, for the customer.

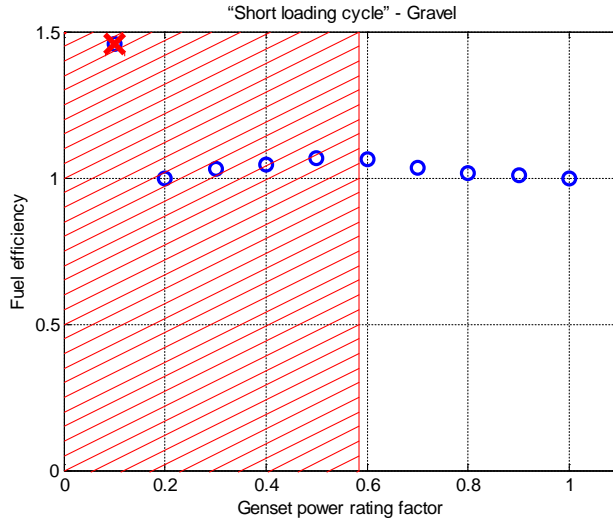

Fig. 5.4. System optimization results on the genset power rating in the series hybrid in Fig. 5.2. The blue circles are different genset power ratings. The lowest power level is crossed out because the cycle time, hence the productivity, was not reached. The red hatched area represents non-viable solutions that violate complete machine performance requirements. Higher fuel efficiency is better. Normalized, to the largest simulated genset - which have a similar power rating as the internal combustion engine in the conventional wheel loader, due to intellectual properties.

The largest contribution to the higher fuel efficiency for the 0.6 power rating is that the average power in the work cycle coincides with the peak efficiency of the 0.6 times reduced power rating genset, see Fig. 5.5. For that reason the energy storage does not need to be used as much as in the gensets with higher power ratings, resulting in that the accumulated losses when charging and discharging the energy storage are lower. In a similar manner, for the gensets with lower power ratings the genset has to work at a higher power level than the highest efficiency work point, resulting in higher overall losses. What do have to be noted here is that this is only from fuel efficiency perspective, with a set productivity, and if implemented the impact of component and subsystem wear and estimated lifetime has to be investigated as well.

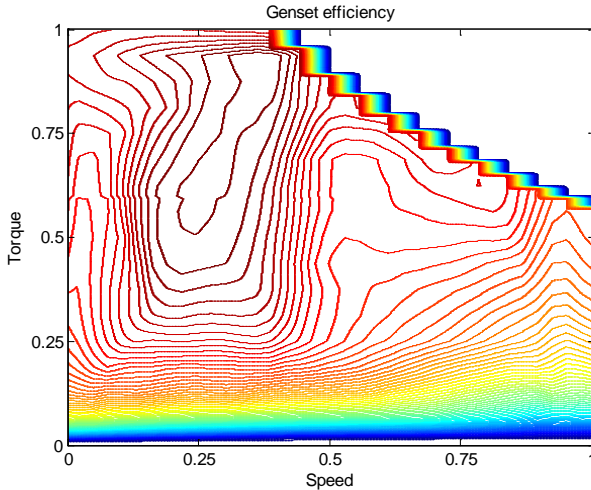

Fig. 5.5. The efficiency map of the genset that are used in the system optimization. The largest genset power rating is shown as an example; the smaller power ratings are scaled versions of the same data. Normalized, to the genset maximum speed and torque, due to intellectual properties.

The most challenging task in the system optimization is to set the component and subsystem boundary conditions due to the versatile usage of a wheel loader. This has to be done by combining complete machine performance requirements and analyzing customer measurement data to ensure that the wheel loader can perform as expected in the required work tasks.

## Result Reasoning

This study is done on a “short loading cycle” from the empirical study in Chapter 2, where the driveline and working hydraulics are working simultaneously throughout the working cycle, predominantly in the bucket fill phase which is a significant part of the “short loading cycle”, as discussed in Chapter 1. For a longer loading cycle, the result is most probably different. When the transport phase is long enough, the extra energy conversion that is present in a full series hybrid wheel loader is not compensated by the savings from the decoupled system in the bucket fill phase, where the simultaneous usage of the driveline and working hydraulics is most present. There will be a breakpoint where the



---

conventional wheel loader, alternatively the parallel hybrid wheel loader, containing a lock-up torque converter is likely the winner instead. Depending on the application and work cycle layout, the highest fuel efficiency will be achieved by different machine concepts. This has to be considered if the results are going to be used in the development of a new machine concept. Hence, several working cycles have to be investigated to ensure that the machine performs as expected at customer sites in all required applications.



## **Chapter 6**

# **Operator Assist, Automatic Functions and Autonomous Machine Control Development Input**

It is shown in Chapter 2 that the operator plays a vital part when it comes to fuel efficiency and productivity. Differences between individual operators are as much as 200% regarding fuel efficiency and 700% regarding productivity [13]. Even among experienced operators, the variation due to operator behavior can be as much as 150% in fuel efficiency and 300% in productivity. Consequently a large fuel savings potential is identified in developing operator assist systems and automatic functions that help the operators and the complete machine control in autonomous machines to be as fuel efficient and productive as possible, resulting in higher profit for the machine owner. Within the near future traditional operator training [29,30] will likely be complemented by more advanced algorithms. This will help the operator, in real time in the cab or off-line by e.g. a report, to solve the work assignment as fuel efficient as possible with as high productivity as possible. A simple off-line operator training tool, based on measurements, consisting of a report handed to the operator after operating the wheel loader is presented in Chapter 2.3. More advanced operator aid, to be discussed in this chapter, can be done at different levels, as defined in Chapter 6.1.

## 6.1 Automation Levels

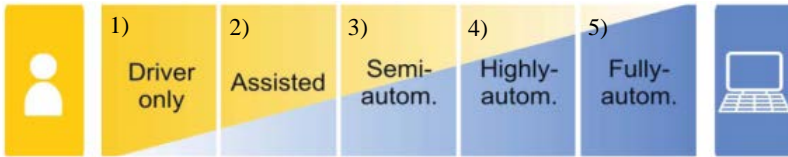

Fig. 6.1 Conventional to fully autonomous [94].

If the nomenclature in Fig. 6.1, which originates from on-road applications, is applied to a wheel loader, it would mean that the machine functionality goes from a conventional to fully autonomous wheel loader according to:

- 1) A conventional wheel loader, where the *operator does all the work*, thinking, planning and controlling.
- 2) A conventional wheel loader with *operator assist*, meaning advanced algorithms that help the operator to operate the wheel loader as fuel efficiently as possible, for the production rate given by the operator. Through off-line reports or human-machine-interaction devices, such as head-up displays and haptic pedals/levers, the recommendations from the algorithms can be communicated to the operator.
- 3) A wheel loader with *semi-automatic functions*, where parts of the work cycle are done by the wheel loader itself at optimum fuel efficiency and productivity, e.g. at a press of a button. A few examples could be: cruise control, automated bucket fill, automated bucket empty, return to dig, etc.. The operator takes over and operates the wheel loader with operator assist systems, as in 1) or 2), in the rest of the work cycle.
- 4) A *highly automated* wheel loader, where the operator shows the wheel loader the work assignment and then the wheel loader solves the task in an optimum way until the operator shows the next work assignment.
- 5) A *fully autonomous* wheel loader, where no operator is involved in the work. The work assignment is defined by the “system operator”, which handles several machines on remote control from a site control room in e.g. an office, and the wheel loader solves the work

assignment in as close to the optimum way as possible until next work assignment is called out by the “system operator”.

However, before deciding upon any automation level between “driver only” and “fully autonomous”, one has to carefully consider which functions, and in what applications, shall be performed by the machine and which shall be performed by the human operator. In [35] it is discussed what is required from an operator assist system and automatic functions to be accepted and used by the human operator.

In order to create trust in an automatic function it has to be established that the automated functions performs well and solves the desired work task successfully. Only then the automatic functionality will be used in real work, and then parameters such as mental workload of the operator can be decreased and fuel efficiency and/or productivity can be increased. However it needs to be transparent to the operator what the automated functions do and in which situations they are designed to work. Ideally, the operator should understand exactly the algorithm, scope and limitations of any automatic function. Due to the complexity of such functions, an understanding at this depth will hardly ever be achieved, but the wheel loader manufacturer must make sure that the assistant system is intuitive in a way that the operator feels that the understanding is there [35].

According to [95], trust in automation guides the operator to rely on it in uncertain situations, even when the complexity of the automated functions makes a complete understanding impractical. However, there is a risk that the operator either over-trusts the automation and therefore misuses it or the operator under-trusts the automation and therefore disuses it, as discussed in [95,96,97,98]. Both misuse and disuse are examples of inappropriate reliance on the automated functions. As [95] argues, this might require an automatic function to be made simpler, rather than more complex. Hence, this is why a choice between level 2) and level 3) in Fig. 6.1 is a good starting point for the introduction of advanced operator assist systems [35].

Making any automatic function adaptive to the situation at hand has to be valued against confusion due to reduced predictability. One example is the activation of a certain level of assistance only when there is a need for it. This requires a consistent behavior, which seems to contradict the idea of supporting the human operator depending on the current need. A solution might be to offer aid at a few distinct levels, informing the

operator clearly on which level is enabled and what type of support that is be given at that level. Once a certain support level has been activated, it should not be deactivated for a foreseeable period of time. It also seems appropriate to permit the operator to explicitly accept or deny this assistance, rather than just activating or deactivating it automatically [35].

## 6.2 Optimal Control Input

Results from the same optimization tool that was used in the concept evaluation and system optimization, presented in Chapter 5, aimed to be used in the beginning of research and development can serve as an input on how the wheel loader should be operated to maximize fuel efficiency at a required productivity. From the optimal control results, the possibility arises to extract real time control strategies, which can be more or less advanced, from predictive or adaptive control based on generated maps from the optimal control results to basic rules that have the potential to be much easier and economical to implement. This can also be intuitive and simple for the operator to learn from. These simple “tips and tricks” can be communicated by, for example, a display in the cab or a head up display with virtual or augmented reality as well as potentially assisted by haptic pedals and levers. The results from the optimal control algorithm can also represent the “Shadow operator”, which is the “optimal” operator in the report based off-line training tool presented in Chapter 2.3.

The benefit with an operator assist system or automatic functions, with regard to fuel efficiency, is visualized in Fig. 6.2. The distribution of the most fuel efficient operator, EP15, and the most fuel efficient cycle, is shown together with all other operators’ average in Fig. 6.2. To benchmark the optimal control results against the best measured cycle from the empirical study in Chapter 2, the cycle time, turning point, position of hauler and gravel pile are fed into the optimization algorithm. The output from the optimization algorithm is movement of the three actuators: propulsion, lift and tilt. The optimal control results, “Theoretical global optimal cycle”, are shown in Fig. 6.2 in comparison to the benchmark cycle, “EP15 best cycle”.

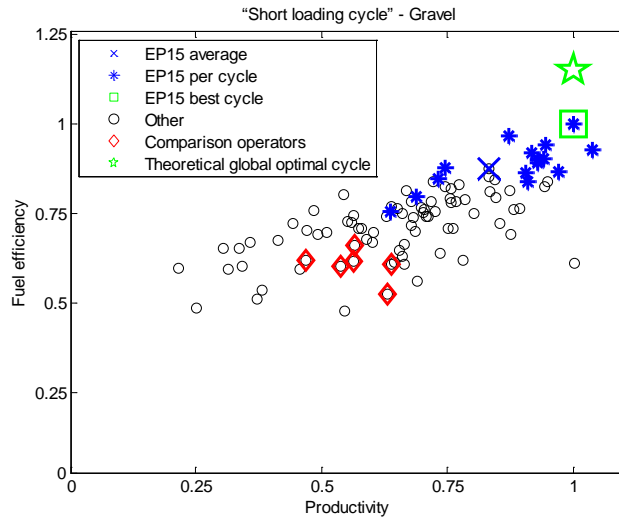

Fig. 6.2. The fuel efficiency and productivity distribution of the operator with the highest average fuel efficiency, EP15, compared to the other operators' average, as in Fig. 2.14. The theoretical global optimum is added as a comparison. Normalized, to the most fuel efficient measured cycle - which is used as benchmark to the optimal control results, due to intellectual properties.

Using the input from the measurements in this way enables to stress the optimization algorithm to ensure that the global optimum result is reached and is feasible. The path planning of the work cycle is not addressed here but rather handled in [53,54,55,56].

### 6.3 Operators vs. Optimal Control

In Fig. 6.2, as red diamonds, a selection of comparison operators are shown as well, chosen randomly in the lower midrange, with respect to fuel efficiency and productivity. The comparison operators were chosen to be able to show the difference between operator behaviors but still not amongst the most inexperienced operators. These serve as comparison operators when analyzing the difference in operator behavior, with regard to controlling the actuators in the wheel loader, and how that impacts the fuel efficiency and productivity.

Some general insights can be made when analyzing the difference between the optimal control results, fuel efficient operators and operators performing in the midrange with regard to fuel efficiency and productivity:

- The optimal control results, the theoretical global optimum found in Chapter 3, can be seen as an idealized version of the empirical optimum found in Chapter 2. The most fuel efficient operators seem to emulate the optimal control result quite well, see Fig. 6.3 and Fig. 6.4.
- The midrange operators most often have a significantly longer cycle time, see Fig. 6.3.
- The midrange operators also tend to hesitate on the levers and pedals, resulting in inharmonic operation of the wheel loader. The midrange operators are using the actuators sequentially instead of in parallel as the most fuel efficient operators do, which is also the case in the trajectories from the optimal control results. This results in lower fuel efficiency and also lower productivity.

In Fig. 6.3, a comparison is shown between the optimal control result, which is the theoretical global optimum calculated in Chapter 3, the most fuel efficient cycle from the operator with the highest average fuel efficiency in the empirical study in Chapter 2, and the selection of comparison operators, chosen randomly in the lower midrange with regard to fuel efficiency and productivity, visible in Fig. 6.2 as red diamonds. The example in Fig. 6.3 shows a one representative work cycle for each comparison operator as an illustration. However, the analysis is based on all the roughly 1200 measured cycles.



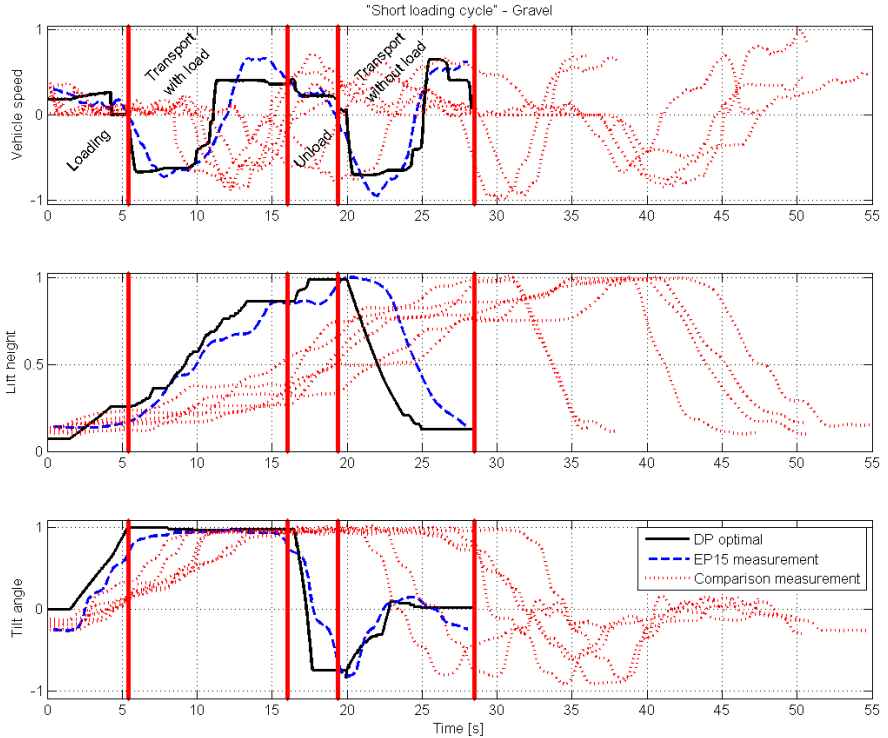

Fig. 6.3. Actuator comparison between the operator with the highest average fuel efficiency, EP15, most fuel efficient cycle, the optimal solution and the comparison cycles from the operators marked in Fig. 6.2. The phase boundaries of “Loading”, “Transport with load”, “Unloading” and “Transport without load” are not valid for the comparison cycles. Normalized, to the highest or lowest utilized speed and position, due to intellectual properties.

When analyzing the difference between the optimal control results, fuel efficient operators and midrange operators it is clear that some events affects the fuel efficiency and productivity more than others. The most predominant is the “Loading” phase [35]. As mentioned in Chapter 4.1, it can be remembered; while the most fuel efficient operator is relatively close to the optimum way of filling the bucket, see Table 4, most of the other operators are not, as already stated in Chapter 2.2 and visualized in Fig. 2.10. Analyzing the bucket fill phase amongst the most fuel efficient operators, the optimal control results can be seen as an idealized version of

the empirical optimum. The most fuel efficient operators seem to emulate the optimal control result, see Fig. 6.4 [63]. The operator with the highest average fuel efficiency does not have a consistent behavior when filling the bucket but rather seems to be really good in adjusting the bucket fill strategy after the current environmental conditions. However, many of the other top-performing operators do have a consistent behavior, here EP4 and EP5 is shown, which both are in the utmost top right corner in Fig. 2.4, “Short loading cycle” – Gravel and definitely competitors to replace EP15 as the “Shadow operator” especially if weighting in productivity.

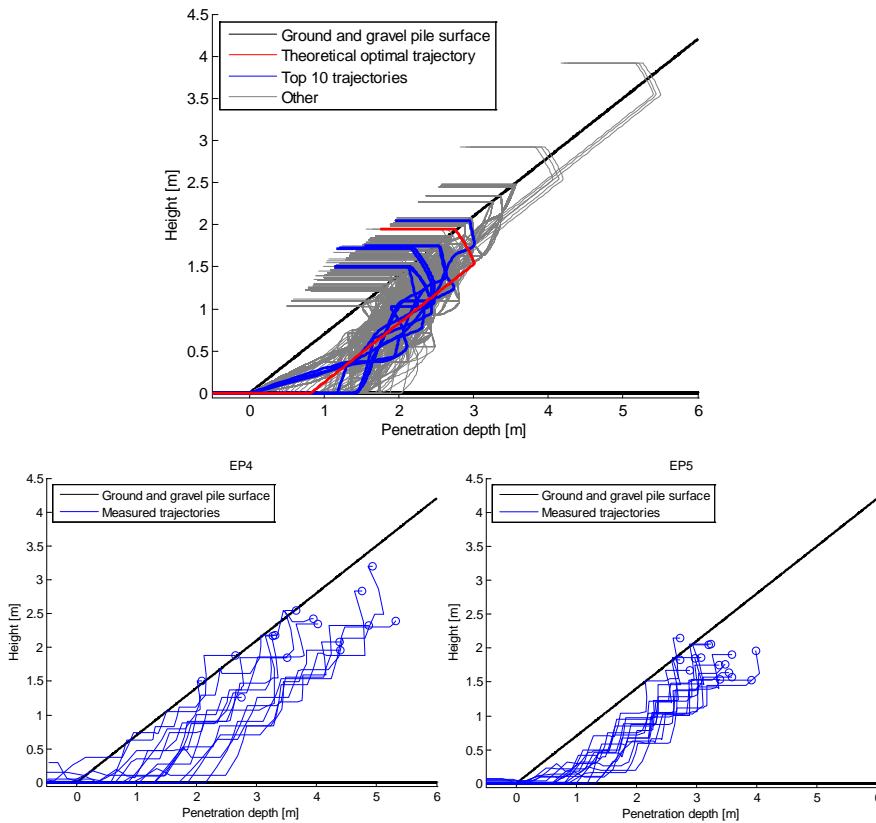

Fig. 6.4. The best trajectory from the optimal control on top of the 10 best trajectories from the optimal control with the rest of the trajectories analyzed in the background, from Fig. 3.9, in the top figure and two of the top-performing operators in the empirical study, in Chapter 2, in the two lower figures as a comparison. Modified from [63].

The main reason why the real operators have a more step-like behavior is due to that then they don't have to control penetration with the driveline, lift and tilt at the same time but rather only the penetration and the lift – then they use the tilt then the pressure is high enough to get less pressure to be able to lift continuously. The offset to the gravel pile is due to that material being removed.

## 6.4 Results

The proposed method, and the algorithms developed in order to implement such method, for extracting input to operator assist systems, automatic functions and autonomous construction machine control development work satisfactory. These inputs, listed in the Operator Assist Systems, Automatic Functions and Autonomous Machine Control subchapters below, are based on the optimal control results from the concept evaluation and system optimization performed in earlier development phases, see Chapter 5 and [9].

The results from the comparison between operators and the optimal control also imply that, if optimal control is used in these advanced functions, the average fuel efficiency can be increased by up to 35-45% for the average operator in Fig. 2.4. This is dependent both on the operator and the application according to the measurements in the empirical study in Chapter 2.

### Operator Assist Systems

The results from the analysis in Chapter 6.3 indicate that the most important factors for achieving high fuel efficiency [ton/l] and productivity [ton/h] in a complete work cycle is to get as low cycle time as possible and as much load in the bucket as possible. To achieve high fuel efficiency and productivity a harmonic operation of the wheel loader is very important. The definition of harmonic operation refers to controlling all necessary actuators smoothly and simultaneously, in a coordinated way when required, see Fig. 6.3 and Fig. 6.4. Recommendations in an operator assist system and/or in an operator manual can include, but are not limited to:

- *Drive as short a distance as the geographical conditions allow while maintaining a harmonic operation of the wheel loader.* It is important not push the machine, preventing that one actuator limits

the work pace. The ideal productivity pace is around 80% of maximum productivity for the wheel loader, see Fig. 2.7 [13].

- At the loading phase, “*slice*” through the pile if possible, depending on material [37,50,63,33].
- *Maintain a continuous movement throughout the entire bucket fill phase and avoid stopping in the gravel pile.*
- At the unloading phase, *drive to the load receiver and keep a continuous tilting-out movement while emptying the bucket. Do not hesitate in either driveline nor tilt actuator movement.*
- After loading and unloading, *position the bucket in a good pace such that it is in position in time for the next task.*
- *Prevent higher lifting than needed.*
- *Select proper gear while machine is in operation.*
- *Prevent unnecessary use of the friction brakes, especially if the wheel loader is equipped with automatic braking functionality during direction changes from forward to reverse or vice versa.*
- *Prevent simultaneous use of the brake pedal and accelerator pedal, to speed up the working hydraulics. (Valid in machines with coupled systems).*

### **Automatic Functions**

According to the analysis in Chapter 6.3, some parts of the work cycle are more suitable than others for automatic functions that can help a midrange operator to achieve higher fuel efficiency [ton/l] and productivity [ton/h]. This is in addition to the automatic functions which are already implemented in wheel loaders today, such as e.g.: automatic gear shift, return to dig, return to dump and automatic braking functionality during direction changes from forward to reverse or vice versa. The most predominant automatic function, with regard to fuel efficiency and productivity, is *automatic bucket fill*, visualized in Fig. 2.10 and investigated further in [63]. However, to lower the cycle time and in that way increase fuel efficiency and productivity, the *unloading* is also an important phase to consider, as can be seen in Fig. 6.3. Important when implementing automatic functions is to consider the operator comfort and take into consideration that accelerations/decelerations and machine

velocity shouldn't affect the machine stability in a way such that the operator feel discomfort or unsafe in the machine. Also whole body vibration limitations have to be considered, to not be exceeded.

### **Autonomous Machines Control**

When it comes to autonomous machine control, the recommendation can be more direct and unrestricted, in regards to operator comfort. If there is no operator present in the autonomous wheel loader, as in level 5) in Fig. 6.1, then the control algorithm can follow the theoretical global optimal solution, calculated in Chapter 3, as close as possible. However, if there is an operator in the wheel loader when operating autonomously, then consideration has to be taken in the same way as for the automatic functions.

### **Limitations and Possibilities**

An important aspect to consider regarding automatic functions, automated machines or autonomous machines are to be able to create trust in these automated functions or systems it is utterly important that the machine can detect and avoid obstacles, hence also accidents, automatically. Also important to mention is that all recommendations given in this thesis is from a fuel efficiency perspective, with a specified productivity. If implemented, one also has to consider if any of these recommendations add additional wear of the machine. In such case the tradeoff between higher fuel efficiency and productivity against higher wear of the machine has to be investigated.

The higher the degree of automation, see Fig. 6.1, the lower the degree of restrictions required on the control system. In the most direct and unrestricted situation, where an autonomous machine can follow the resulting trajectories from the optimal control calculations exactly, depending if operator comfort for the human co-operator has to be considered, the highest fuel efficiency gain can be expected. The lower the degree of automation, according to Fig. 6.1, the more the operator has to be involved in the control loop, which results in that restrictions may have to be put on the automated system. This is because when aiming at the automatic functions there is an operator present that needs to trust the system, meaning that not only the comfort of the operator has to be considered but also how the machine solves a specific task automatically. It has to be intuitive for the operator so that the he or she can trust that the

machine fulfills the task in a good way. To further elaborate, the operator assist system should consider simple recommendations to minimize the mental workload of the operator when trying to follow the directions. This type of human-machine interaction is an extensive research area more focused on human cognition, which is not covered in this thesis.

In a similar manner: if the machine is fully autonomous the machine already knows how the work cycle looks like and it can optimize for that directly. However if there is an operator present in the machine, he or she decides how the work cycle layout. This means that for the lower automation degrees, where an operator is still in control of the wheel loader, the machine itself has to be able to identify the work cycle and detect where in the work cycle it is operating at each time. This can be done with e.g. the pattern recognition algorithm presented in [99,100,101] which has been demonstrated to be able to run on an on-board computer in a wheel loader. Even if it is a prerequisite to run the pattern recognition in real time, the optimization algorithms presented in Chapter 3 do not have that requirement and cannot be run in real time, since it would take weeks to do only one work cycle optimization in the on-board computers available on the wheel loader today. However a potential solution may be to perform a set of optimizations, for different work cycles and different materials, off-line on a cluster and save the results in the form of tables in the on-board computer. Then, operator assists systems or automated function algorithms could retrieve this information directly in the machine when needed.

# Chapter 7

## Discussion and Future Work

The method and algorithms developed and presented in this thesis are demonstrated on three diesel-electric wheel loader concept machines with promising results, which further implies that the method is also applicable to any of the other wheel loader concepts in the two-dimensional matrix in Fig. 5.1. Due to the implementation and calculation time, and also to the sheer amount of concepts in each cell in the matrix, engineering judgment is needed in order to screen the concepts that are worthwhile to evaluate with the optimization tool. To evaluate one concept, the computation time is about four hours on a laptop with a 64-bit Microsoft Windows 7, Intel Core i7-4800MQ @ 2.70GHz quad core CPU and 16GB RAM. The calculations of each machine concept and system setup can be optimized in parallel. This means in one week's time on eight cores a batch of 336 machine concepts can be simulated, which is acceptable from a development calendar time perspective.

The feasibility of separating the optimization of the actuators and primary energy converters in Fig. 5.2, is supported when done on the full series hybrid wheel loader, if comparing to measurements. However, it is known that there are limitations when it comes to coupled systems, such as the conventional and parallel hybrid wheel loader [69,70]. The calculations tend to favor the conventional and parallel hybrid, to a slighter extent, in the concept evaluation. The separation in the optimization is made to limit the computational effort. However, if the necessary computational power is available, by e.g. access to a computing cluster or by using cloud computing, the optimization should be performed on a complete machine. The same is valid for the path planning optimization of the work cycle presented in [53,54,55,56]. To really ensure a global optimum on the

complete operation of the wheel loader, the path planning should be incorporated in the same optimization tool. This is however not possible, with the methods investigated and the computational power available, today in early 2018, due to computational constraints. Regardless, of whether the optimization is done on a complete machine – i.e. considering the primary energy converter and actuators at the same time - and whether the path planning is included in the same optimization or not, it is still equally important to properly decide upon the complete machine performance requirements, due to the fact that it is often these that set the size of most of the major subsystems and components, as discussed in Chapter 5.2.

It is important to mention the limitations in the concept evaluation and system optimization tool presented. The optimization tool is focused on fuel efficiency [ton/l] and productivity [ton/h]. Fuel efficiency is the main target, but a Pareto front with different productivity levels can be created if performing the optimization with different  $\beta$  in (3.1). Also, due to the focus on fuel efficiency, factors such as component cost and development effort have to be considered separately.

A wheel loader, which is part of a production chain, performing a “short loading cycle” in a rehandling bucket application, meaning that the wheel loader is loading crushed material onto a load receiver standing next to the gravel pile, is used as an example. However, it is important to take into consideration that when using the optimization tool presented in research and development in industry, many more work cycles have to be evaluated due to the versatile usage of a wheel loader, in order to ensure that the machine performs as expected at customer sites in all different applications. This is due to two reasons; first, and most important, to set the complete machine performance requirements, as discussed in Chapter 5.2, and second also to investigate the fuel efficiency in different production rates, work cycles and applications to ensure an as fuel efficient machine as possible over all. One method of selecting work cycles to incorporate in a new machine concept evaluation is presented in [102,103] where an automatic selection of a representative operating cycle in large measurements is presented. Data can be collected from customers in the field worldwide and then the most representative cycles can be selected to investigate the true fuel efficiency potential in real world operation. Then the toughest work cycles have to be added as design criteria’s to ensure that the machine can handle the anticipated work tasks in the field.



For the same reasons, an implementation of the advanced functions: operator assist systems, automatic functions and autonomous machine control, have to be validated in a similar representative set of work cycles at several customer sites before launched to customers. The result will most probably vary depending on application, material, attachment, environment and operator. However, this could be solved with a set of optimizations that constitutes a library for different applications, material and attachment. The algorithms in the advanced functions can then use that library depending on the current work site conditions.

In addition, the operator assist system is dependent on a work cycle detection algorithm to know what cycle is ongoing and where in that work cycle the machine is at any moment. In [62], an attempt is made to identify the application, however this was not very successful. A pattern recognition focusing on machine behavior was developed in [99,100,101] instead. The pattern recognition algorithm is built on the detection of a series of events, such as loading, gear change reverse to forward, emptying and then gear change reverse to forward again for example, is detected in a certain order. This, in turn, builds up a “short loading cycle” in a bucket application [99,100]. A number of chosen characteristic parameters can then be extracted from the pattern recognition to serve as input to an optimization of the work cycle. Consideration is also taken to small differences in the work cycle, for example the cycle becomes a bit longer for every bucket of soil that is taken away when digging from a “virgin” bank. The results from that optimization can then be used in an operator assist system. Automatic functions can be more or less dependent on the work cycle detection algorithm, depending on the nature of the work tasks that are to be automated. In the case of semi-autonomous machines it can be argued that the operator shows the machine how to solve the task, hence no work cycle detection is needed. In the same manner the “system operator”, as explained in conjunction with Fig. 6.1, defines the task for the full autonomous machine.

Especially in the full autonomous machine, but also in the semi-autonomous machine the performance of the wheel loader is highly dependent on the quality of the sensors and the algorithms utilizing the sensors. One example worth considering is the vision system that should not only be able to plan the path without colliding with obstacles but also identify and analyze the gravel pile in a way such that the filling of the bucket is performed in the correct place geographically and also as optimal

as possible in conjunction with the optimal control results. Meanwhile there has to be a system that senses the traction to avoid slip when filling the bucket and another that ensures that the bucket becomes fairly filled with material.

In any of the cases related to the advanced functions, trust in automation is critical, otherwise the functionality will not be utilized. However, it is also worth mentioning the importance of consistent behavior, high up-time and low error rate of the system. Because one failure, that for example causes a collision, can easily result in higher costs than the savings expected from several years of several years of higher fuel efficiency.

The optimal control based method for concept evaluation and advanced system development input presented can also be used for other construction machines such as excavators and articulated haulers. Other complex machines, such as agriculture and forestry equipment can most likely, with some minor modifications, use the same method to evaluate new machine concepts and provide input to the development of operator assist systems, automatic functions and autonomous machine control. On-road vehicles can be analyzed with this method as well, however the advantages from already existing methods are limited compared to the more complex machines with material interaction and multiple actuators with the parallel power flow visualized in Fig. 1.5.

# Chapter 8

## Conclusions

From the empirical study presented in Chapter 2, it is concluded that *the operator plays a vital part for fuel efficiency and productivity*. Fuel efficiency differences of up to 200% and productivity differences of up to 700% between novice and professional operators can be seen in Fig. 2.4. Even if the novice operators are excluded, fuel efficiency differences of up to 150% and productivity differences of up to 300% have been measured. From a fleet perspective, considering the average of all operators, fuel efficiency improvements of up to 20-40% and productivity improvements of up to 40-80% are possible, depending on the application.

The fuel efficiency and productivity level seem to be somewhat proportional to the experience, or skill level, of the operator, within the limitations of the measurement. This means that a site manager can calculate the payback time of operator training courses, advanced operator assist systems or automatic functions implementations in the machine based on that. *The application plays an important role*, so even if a site manager employs an experienced operator it could be useful to train the operator within that specific application because it could significantly differ from what the operator is familiar with. The deviation from the average fuel efficiency and productivity for a single operator in one specific application, excluding novice operators, is typically between 10-20%, as can be seen in Fig. 2.5, both regarding fuel efficiency and productivity. This shows the potential in *encouraging the operator to learn from him or herself*. A potential bonus system could encourage the operators to perform their best with regard to fuel efficiency and productivity as well as solving the work assignment. If a site manager understands the trade-off curves, the manager can control the choice of

wheel loader size, set the production rate and optimize the overall efficiency of the complete site. This requires that the trade-off curves for all the machinery on the site is known. Data to accomplish this can be accumulated telemetrically by a site measurement tool.

The proposed off-line, report based training tool in Chapter 2.3 shows that it should be possible to record a number of operators, perform an automated analysis and present the results in different levels for the operators. The operator can *analyze the behavior and identify performance metrics* to improve next time. The training tool can be based on the operator's best cycles or the best operator on the work site, as in Chapter 2.3, or even on a calculated theoretical global optimum, as the one calculated in Chapter 3 in the same manner as when extracting input to operator assist system in Chapter 6. The training tool has significant potential for a competent trainer who can analyze the results and provide constructive feedback to help improve the operator's behavior.

For most operators, assistance in the bucket fill phase would have a significant impact on fuel efficiency, as shown in Chapter 6.3 and Fig. 2.10. This could be solved by an automated bucket fill, where the wheel loader fills the bucket on its own, in as close to the optimum way as possible, from an operator simply pressing a button. *Automatic bucket fill should be designed* to fill the bucket to its maximum capacity and automatic dumping should target as short time as possible in the emptying phase as possible in order to improve productivity. *An operator assist system should aim at helping the operator to operate the wheel loader faster* to get through the work cycle in a shorter amount of time, as can be seen in Fig. 6.3. One way of achieving this is by decreasing the number of control inputs that the operator has to manage, for example an extended version of the already existing return to dig function, where the operator only has to control one actuator.

It is concluded in Chapter 4.3 that when evaluating optimal bucket fill strategy simple performance indicators are not enough, a complete machine, complete work cycle optimization that ensures global optimum should be performed to ensure correct results. The main challenge when optimizing actuator trajectories in a complete work cycle of a wheel loader in bucket applications is the heavy computations needed to calculate the bucket-soil interaction in the bucket fill phase. It is *critical to get accurate bucket forces* during this important work phase where up to one third of the energy in a work cycle is spent [33]. The optimal control method and

the implemented algorithms presented find a theoretical global optimum that has approximately *14% higher fuel efficiency in a complete work cycle* compared to the best cycle of the most fuel efficient operator found in the empirical study in Chapter 2, in a “short loading cycle”, bucket application with crushed material, as can be seen in Fig. 4.4 and Table 4. This result in roughly 45% higher fuel efficiency in a complete work cycle, compared to the average of all the operators in the empirical study, see Fig. 2.4. In the example of a wheel loader with timber grapple unloading a truck, the theoretical global optimum has approximately 12% higher fuel efficiency compared to an experienced operator on a customer site, as can be seen in Fig. 4.6. The algorithm can be used to optimize productivity or a combination of fuel efficiency and productivity, as well.

The proposed method and the algorithms developed work well when *performing concept evaluation and system optimization* of new machine concepts and should be able to cover all diesel-electric machine concepts in the matrix in Fig. 5.1. A production chain wheel loader in a bucket application is used as an example but other applications and other construction machines or similar, such as agriculture and forestry equipment, can be investigated as well. The investigated example, where a conventional machine is compared with a parallel and a series hybrid wheel loader, shows, in Fig. 5.3, that the *parallel hybrid is about 5% more fuel efficient [ton/l]* than the conventional one, while the *series hybrid is around 23% more fuel efficient*, at the same productivity [ton/h]. Furthermore, an example of system optimization of the genset, internal combustion engine and electrical machine, in the series hybrid wheel loader shows, in Fig. 5.4, *approximately 6% higher fuel efficiency, at the same productivity, with optimal sizing*. Diesel-electric hybrid wheel loaders are used as an example, however different machine concepts, such as diesel-hydraulic hybrids, full electric machines, different transmissions topologies, e.g.; converter with or without lockup, hydrostatic or continuous variable transmission, etc. are possible to investigate as well. Using the method presented *minimize the dependency on control engineer experience and competence, development time, operator deviations and test repeatability* when estimating the fuel efficiency potential of different machine concepts and advanced functions.

It is demonstrated that the optimal control results, already available from the concept evaluation and system optimization in early research and development phases, *can be used as input in the development of advanced*

*functions*, such as operator assist systems, automatic functions and autonomous machine control in the final research and development phases. The main advantage in using optimal control is that the optimal solution can be seen as an *idealized version* of the empirical optimum, as can be seen in Fig. 6.3 and Fig. 6.4. This can be used in an operator assist system, once a pattern recognition algorithm is in place and the optimization can either be calculated in real time, or retrieved from a library of previously off-line calculated cases, which can then be slightly modified in real time until optimal operation is reached. This can be used instead of, or in conjunction with as a faster alternative, finding the empirical optimum at every customer site, which is the traditional approach in operator training and is a quite tedious task and very dependent on the trainer, in for example [27,29]. In the development of automatic functions and autonomous machines the optimal control results can be used more or less as they are, depending on whether there is an operator present in the cab or not, whose comfort and health and safety concerns must be addressed uppermost. The method shows potential *to increase the fuel efficiency [ton/l] up to 35-45% for the average operator* in Fig. 2.4, depending on automation degree, while maintaining, or increasing, the desired productivity [ton/h]. An example of optimizing towards fuel efficiency is shown, but the optimization tool can be adjusted to optimize towards productivity as well, or a combination of the two.

The optimization method and algorithms presented can serve as a tool in *early development phases* when performing concept evaluations and system optimizations on new machine concepts. The optimal control results can then be used *as input to* operator assist systems, automatic functions and autonomous construction machine control development. However, there is still work to do before implementation into the research and development process in industry. The method and algorithms have to be tested, stressed and *validated in many more work cycles* and at different customer sites.

# References

Internet links verified 2018-03-18.

---

- [1] Filla, R., “Quantifying Operability of Working Machines”, Linköping University, ISBN: 978-91-7393-087-1, 2011.
- [2] Löfgren, B., “Automation of Forestry Machines - an Important Piece in Precision Forestry”, International Precision Forestry Symposium, Stellenbosch University, South Africa, 2006.
- [3] Kormann, G., “Operator Assist Systems for Agricultural Vehicles - Overview about Guidance and Automation Solutions”, Commercial Vehicle Technology Symposium (CVT 2010), Kaiserslautern, Germany, March 16-18, 2010.
- [4] Ringdahl, O., “Automation in Forestry – Development of Unmanned Forwarders”, Department of Computing Science Umeå University, ISBN: 978-91-7459-213-9, 2011.
- [5] Dadhich, S., Bodin, U., Andersson, U., “Key challenges in automation of earth-moving machines”, Automation in Construction, Volume 68, pp. 212-222, August 2016.
- [6] Sakaida, Y., Chugo, D., Yamamoto, H., Asama, H., ”The Analysis of Excavator Operation by Skillful Operator - Extraction of common skills”, SICE Annual Conference, August 20-22, 2008.
- [7] Källquist, M., Seye-Larsen, E., ”Development, Modelling and Implementation of Cartesian Drill Bit Control”, Fluid and Mechanical Engineering Systems, LIU-IEI-TEK-A--09/00564—SE, 2009.
- [8] Yoon, J., Manurung, A., “Development of an Intuitive User Interface for a Hydraulic Backhoe”, Automation in Construction, Volume 19, Issue 6, pp. 779-790, October 2010.
- [9] Frank, B., “Using Optimal Control in Concept Evaluation and System Optimization of Diesel-Electric Hybrid Construction Machines” Accepted to 4<sup>th</sup> International Conference on Electrical Systems for Aircraft, Railway, Ship propulsion and Road Vehicles & International Transportation Electrification Conference (ESARS ITEC 2016), Toulouse, France, November 2-4, 2016.
- [10] Frank, B., “Utilizing Optimal Control and Physical Measurements when Developing Operator Assist, Automatic Functions and Autonomous

- 
- Machines” 6<sup>th</sup> IEEE International Conference on Control System, Computing and Engineering (ICCSCE 2016), Batu Ferringhi, Penang, Malaysia, November 25-27, 2016.
- [11] Casoli, P., Gambarotta, A., Pompini, N., Riccò, L., ” Hybridization methodology based on DP algorithm for hydraulic mobile machinery — Application to a middle size excavator”, *Automation in Construction*, Volume 61, Pages 42-57 January 2016.
- [12] Chauvin, A., Sari, A., Hijazi, A., Bideaux, E., ” Optimal sizing of an energy storage system for a hybrid vehicle applied to an off-road application”, 2014 IEEE/ASME International Conference on Advanced Intelligent Mechatronics (AIM) Besançon, France, July 8-11, 2014.
- [13] Frank, B., Skogh, L., Alaküla, M., “On Wheel Loader Fuel Efficiency Difference due to Operator Behaviour Distribution”. 2<sup>nd</sup> Commercial Vehicle Technology Symposium (CVT 2012), Kaiserslautern, Germany, March 13-15, 2012.
- [14] Nurmi, J, Mattila, J, “Global Energy-Optimal Redundancy Resolution of Hydraulic Manipulators: Experimental Results for a Forestry Manipulator” *Energies*, vol 10, no. 5, 647, 2017.
- [15] Nurmi, J, Mattila, J, “Global energy-optimised redundancy resolution in hydraulic manipulators using dynamic programming”, *Automation in Construction*, Volume 73, Pages 120-134 January 2017.
- [16] Frank, B., Fröberg, A., “Establishing an Optimal Work Cycle for an Alternative Wheel Loader Concept”. International Exposition for Power Transmission (IFPE 2014), Las Vegas, USA, March 4-8, 2014, ISBN: 0-942220-49-8, ch 11.1., 2014.
- [17] Kaneko, S., Ikimi, T., Moriki, H., Ito, N., Yanagimoto, H. “Patent US20130151055A1”, 2013.
- [18] Bennik, C. “Wheel Loader Production Tips” <http://www.forconstructionpros.com/article/10299484/wheel-loader-production-tips>, 2006.
- [19] Volvo Construction Equipment Media Library.
- [20] Hendley, N., “Take a Load Off in On-Site”, March 2011.
- [21] Unnebäck, J., “Total Cost of Ownership calculation spreadsheet”. Volvo internal document, 2017.
- [22] Morrin, N., “Energy Best Practice Guide for Tractors – Fleet/Site Managers”, Skanska, , 33M : V2, May 2008.
- [23] Volvo Construction Equipment Site Simulation Tool, <http://sitesim.net/>
- [24] Press information, “Doosan DL300 wheel loader offers productive, fuel-efficient operation”, 2011.
- [25] Press information, “Volvo Construction Equipment OPTIshift for L150F, L180F, L220F”, 2010.
- [26] Volvo Performance Manual, Volvo internal report, 2016.



- 
- [27] “Performance Optimization Training”, <http://www.quarryengineers.com> at <http://quarrymanager.com>.
- [28] Bennink, C., “Wheel Loader Designs Squeeze Out More Fuel Efficiency Without Sacrificing Productivity - Squeeze Fuel Costs”, April 2009.
- [29] Volvo Construction Equipment Eco Operator Training, <https://www.volvoce.com/global/en/our-offer/operator-training/>.
- [30] <http://www.minemachinetraining.com.au/>
- [31] North Pacific Training and Performance – [www.north-pacific.ca](http://www.north-pacific.ca), Inc., “Loader Operator Training Manual (Sample Pages) 992 G Wheel Loader”, <http://www.north-pacific.ca/LoaderManual-Sample-English.pdf>
- [32] Filla, R., “Operator and Machine Models for Dynamic Simulation of Construction Machinery”, Linköping University, ISBN: 91-85457-14-0, 2005.
- [33] Filla, R., Obermayr M., Frank., B. “A Study to Compare Trajectory Generation Algorithms for Automatic Bucket Filling in Wheel Loaders”, 3<sup>rd</sup> Commercial Vehicle Technology Symposium (CVT 2014), Kaiserslautern, Germany, March 2014.
- [34] Filla, R., “Hybrid Power Systems for Construction Machinery: Aspects of System Design and Operability of Wheel Loaders”, ASME IMECE 2009, Vol. 13, pp. 611-620, 2009.
- [35] Frank, B., Skogh, L., Filla, R., Alaküla, M., “On Increasing Fuel Efficiency by Operator Assistant Systems in a Wheel Loader”. 2012 International Conference on Advanced Vehicle Technologies and Integration (VTI 2012), China Machine Press, ISBN: 978-7-111-39909-4 or 978-7-89433-726-9, pp. 155-161, Changchun, China, July 16-19, 2012.
- [36] Backas, J., Ghabcheloo, R., Tikkanen, S., Huhtala, K., “Fuel optimal controller for hydrostatic drives and real-world experiments on a wheel loader, International Journal of Fluid Power”, 17:3, 187-201, 2016.
- [37] Filla, R., “Evaluating the Efficiency of Wheel Loader Bucket Designs and Bucket Filling Strategies With Non-coupled DEM Simulations and Simple Performance Indicators”, Fachtagung Baumaschinentechnik 2015, Dresden, Germany, 2015.
- [38] Johannesson, L., “On Energy Management Strategies for Hybrid Electric Vehicles”. Department of Signals and Systems, Chalmers University of Technology, Göteborg, Sweden, 2006.
- [39] Ottosson, J., “Energy Management and Control of Electrical Drives in Hybrid Electrical Vehicles”, Department of Industrial Electrical Engineering and Automation, Lund University, Sweden, 2007.
- [40] Larsson, V., “Route Optimized Energy Management of Plug-in Hybrid Electric Vehicles” ISBN: 978-91-7597-002-8, 2014.

- 
- [41] Hung, C-W., Vu, T-V., Chen, C-K., "The Development of an Optimal Control Strategy for a Series Hydraulic Hybrid Vehicle", *Applied Sciences* 6, no. 4: 93, 2016.
- [42] Molla, S., Ayalew, B., "Power management strategies for a Series hydraulic hybrid drivetrain", *Int. J. Powertrains*, Vol. 1, No. 1, pp.93-116, 2011.
- [43] Wu, B., Lin, C-C., Filipi, Z., Peng, H., "Optimal power management for a hydraulic hybrid delivery truck", *Vehicle System Dynamics*, Vol. 42, Nos. 1-2, pp. 23-40, 2004.
- [44] Nilsson, T., "Optimal Predictive Control of Wheel Loader Transmissions", Linköping University, ISBN: 978-91-7519-171-3, 2015.
- [45] Baer, K., "Simulation-Based Optimization of a Series Hydraulic Hybrid Vehicle", Linköping University, ISBN: 9789176853443, 2018.
- [46] Zimmerman, J., Hippalgaonkar, R., Ivantysynova, M., "Optimal Control for the Series-Parallel Displacement Controlled Hydraulic Hybrid Excavator", *ASME 2011 Dynamic Systems and Control Conference and Bath/ASME Symposium on Fluid Power and Motion Control, DSCC 2011.1.10.1115/DSCC2011-5996*, 2011.
- [47] Hippalgaonkar, R., Ivantysynova, M., Zimmerman, J., "Fuel savings of a mini-excavator through a hydraulic hybrid displacement controlled system", *8<sup>th</sup> International Conference on Fluid Power (IFK)*, Dresden, Germany, 2012.
- [48] Wang, F., Zulkefli, M. A. M., Sun, Z., & Stelson, K. A., "Investigation on the energy management strategy for hydraulic hybrid wheel loaders", *ASME 2013 Dynamic Systems and Control Conference, DSCC 2013 (Vol. 1)*. [V001T11A005] American Society of Mechanical Engineers (ASME), 2013.
- [49] Shen, W., Jiang, J., Su, X., Karimi, R H., "Control strategy analysis of the hydraulic hybrid excavator", *Journal of the Franklin Institute*, Volume 352, Issue 2, Pages 541-561, ISSN 0016-0032, 2015.
- [50] Frank, B., Kleinert, J., Filla, R., "Optimal Control of Wheel Loader Actuators in a Complete Work Cycle in Gravel Applications", *Automation in Construction*, Volume 91, Pages 1-14, July 2018.
- [51] Fu, J., "Logistics of Earthmoving Operations", KTH Royal Institute of Technology, ISBN: 978-91-87353-05-5, 2013.
- [52] Rylander, D., "Productivity Improvements in Construction Site Operations Trough Lean Thinking and Wireless Real-Time Control", Mälardalen University, ISBN: 978-91-7485-173-1, 2014.
- [53] Nezhadali, V., Frank, B., Eriksson, L., "Wheel Loader Operation - Optimal Control compared to Real Drive Experience", *Control Engineering Practice*, Volume 48, Pages 1-9, March 2016.

- 
- [54] Filla, R., "Optimizing the Trajectory of a Wheel Loader Working in Short Loading Cycles". 13<sup>th</sup> Scandinavian International Conference on Fluid Power, Linköping, Sweden, 2013.
- [55] Nezhadali, V., Eriksson, L., "Optimal Lifting and Path Profile for a Wheel Loader Considering Engine and Turbo Limitations", Optimization and Optimal Control in Automotive Systems, Springer Lecture Notes in Control Science, 2014.
- [56] Hong, B., Ma, X., "Path Planning for Wheel Loaders: a Discrete Optimization Approach", IEEE 20th International Conference on Intelligent Transportation Systems (ITSC), 2017.
- [57] Dunston, P. S., Proctor, R. W., Wang, X., "Challenges in evaluating skill transfer from construction equipment simulators", Theoretical Issues in Ergonomics Science, Volume 15, 2014 - Issue 4, Published online: 25 Oct 2011.
- [58] Volvo Certified operator trainer Work Book, Version 11-08, Volvo Construction Equipment, 2008.
- [59] Caterpillar Performance Handbook, Edition 47, 2017.
- [60] Volvo L150H, L180H, L220H Product Brochure, 2018.
- [61] Bohman, M., "On Predicting Fuel Consumption and Productivity of Wheel Loaders", Luleå University of Technology, ISSN: 1402-1617, 2005.
- [62] Karlsson J., "Application and Material Identification for a Wheel Loader", Mälardalens Högskola, 2010.
- [63] Filla, R., Frank, B., "Towards Finding the Optimal Bucket Filling Strategy Through Simulation", 15<sup>th</sup> Scandinavian International Conference on Fluid Power – Fluid Power in the Digital Age (SICFP'17), June 7-9, 2017.
- [64] Ek, D. F., Mulisic, A., "Entry barriers on the training simulator market for construction vehicles in Europe", Linnaeus University, 2010.
- [65] Stein, G., Fröberg, A., Martinsson, J., Brattberg, B., Filla, R., Unneback, J., "Fuel Efficiency in Construction Machines – Optimize the Machine as a System", 7<sup>th</sup> AVL International Commercial Powertrain Conference 2013, Graz, Austria, May 22-23, 2013.
- [66] Press information, "Building the world we want to live in", Volvo Spirit Magazine, 61:10-13, 2016.
- [67] Vigholm, B., "Baseline\_V31\_111107\_OC091052\_run3\_10hz\_cut\_compare.xls", Volvo internal report, 2011.
- [68] Alaküla, M., "Hybrid Drive Systems for Vehicles - Part I - System Design and Traction Concepts", Lunds Tekniska Högskola, Lund 2006-11-05.
- [69] Tang, L., Rizzoni, G., Lukas, M., "Comparison of Dynamic Programming-based Energy Management Strategies Including Battery Life Optimization", 4<sup>th</sup> International Conference on Electrical Systems for Aircraft, Railway, Ship propulsion and Road Vehicles & International

- 
- Transportation Electrification Conference (ESARS ITEC 2016), Toulouse, France, November 2-4, 2016.
- [70] Tang, L., "Optimal energy management strategy for hybrid electric vehicles with consideration of battery life", Ohio State University, 2017.
- [71] Bryson, A., Ho, Y., "Applied Optimal Control: Optimization, Estimation and Control", ISBN-13: 000-0891162283, 1975.
- [72] Bellman, R., "Dynamic Programming", Courier Corporation, ISBN: 9780691146683, originally published 1957.
- [73] Diehl, M., "Numerical Optimal Control - DRAFT", June 1, 2011.
- [74] Betts, J.T., "Practical Methods for Optimal Control Using Nonlinear Programming", SIAM, Philadelphia, ISBN: 978-0-89871-688-7, 2001.
- [75] Pourabdollah, M., "Optimization of Plug-in Hybrid Electric Vehicles", Chalmers University of Technology, ISBN: 978-91-7597-149-0, 2015.
- [76] Nezhadali, V., Eriksson, L., Fröberg, A., "Modeling and Optimal Control of a Wheel Loader in the Lift-Transport Section of the Short Loading Cycle", 7<sup>th</sup> IFAC Symposium on Advances in Automotive Control. Tokyo, Japan, 2013.
- [77] PROPT, "<http://www.tomdyn.com/>", tomlab 7.9.
- [78] Bertsekas, D., "Dynamic Programming and Optimal Control", vol 1-2, ISBN: 1-886529-08-6 (Two-volume set), 2007.
- [79] Miettinen, K., "Nonlinear Multiobjective Optimization", ISBN: 0-7923-8278-1, fourth printing, 2004.
- [80] Marler, R.T., Arora, J.S., "Survey of Multi-Objective Optimization Methods for Engineering", Structural and Multidisciplinary Optimization, Volume 26, Issue 6, pp. 369-395, April 2004.
- [81] Guzzella, L., Sciarretta, A., "Vehicle Propulsion Systems - Introduction to Modeling and Optimization", 2<sup>nd</sup> Edition, Softcover ISBN: 978-3-642-09415-6, Springer-Verlag Berlin Heidelberg, 2007.
- [82] Svensson, H., "Gravel Pile Model Verification", Volvo internal report, 2012.
- [83] Ericsson, A., Slättengren, J., "A Model for Predicting Digging Forces when Working in Gravel or Other Granulated Material", 15<sup>th</sup> ADAMS European Users Conference, Rome, 2000.
- [84] Yoshida, T., Koizumi, T., Tsujiuchi, N., Jiang, Z., "Digging Trajectory Optimization by Soil Models and Dynamics Models of Excavator", SAE International, 2013.
- [85] Obermayr M., Vrettos C., Kleinert J., et al. "A Discrete Element Method for Assessing Reaction Forces in Excavation Tools", Congress on Numerical Methods in Engineering (CNM 2013), Bilbao, Spain, June 2013.

- 
- [86] Obermayr M., Dressler K., Vrettos, C., Eberhard P., "Prediction of Draft Forces in Cohesionless Soil with the Discrete Element Method", *Journal of Terramechanics*, 48(5):pp. 347-358, 2011.
- [87] Obermayr, M., Dresser K., Vrettos C., et al. "A Bonded-Particle Model for Cemented Sand." *Computers and Geotechnics*, 49: pp. 299-313, 2013.
- [88] Ergenzinger C., Seifried R., Eberhard P., "A Discrete Element Model to Describe Failure of Strong Rock in Uniaxial Compression." *Granular Matter*:13(4): pp. 1-24, 2010.
- [89] <http://www.cs.utah.edu/~germain/PPS/Topics/recursion.html>
- [90] Sjöström, L., Filla, R., Unneback, J., "HeWL – Final Report", Volvo internal report, Eskilstuna, Sweden, October 22, 2010.
- [91] Unneback, J., "Productivity Test SCL\_L&C\_pall\_fuel rail dec 2011", Volvo internal report, 2011.
- [92] Heybroek, K., "On Energy Efficient Mobile Hydraulic Systems – with Focus on Linear Actuation", Linköping University, ISBN: 978-91-7685-511-9, 2017.
- [93] "More Power and Less Fuel" <http://www.volvoce.com/dealers/eng-drillconraj/products/innovations/hybrids/Pages/Introduction.aspx>, 2007.
- [94] HAVEit Booklet Final Event, June 21-22, 2011.
- [95] Lee, J. D., See, K. A., "Trust in Automation. Designing for Appropriate Reliance". *Human Factors*, vol. 46, no. 1, pp. 50-80, 2004.
- [96] Parasuraman, R., Riley, V., "Humans and Automation: Use, Misuse, Disuse, Abuse". *Human Factors*, vol. 39, no. 2, pp. 230-253, 1997.
- [97] Lee, J. D., "Review of a Pivotal Human Factors Article: 'Humans and Automation: Use, Misuse, Disuse, Abuse'". *Human Factors*, vol. 50, no. 3, pp. 404-410, 2008.
- [98] Parasuraman, R., Manzey, D. H., "Complacency and Bias in Human Use of Automation: An Attentional Integration". *Human Factors*, vol. 52, no. 3, pp. 381-410, 2010.
- [99] Nilsson, T., Sundström, C., Nyberg, P., Frisk, E., Krysander, M., "Robust Driving Pattern Detection and Identification with a Wheel Loader Application", *International journal of vehicle systems modelling and testing*, 9(1): 56-76, 2014.
- [100] Ohlsson-Öhman, K., "Identifying Operator Usage of Wheel Loaders Utilizing Pattern Recognition Techniques", Linköping University, 2011.
- [101] Palm, W., Skogh, M., "Wheel Loader Cycle Recognition Software Evaluation", student summer work, Volvo internal report, 2016.
- [102] Samuelsson, T., Filla, R., Frank, B., Skogh, L., "Selecting Representative Working Cycles from Large Measurement Data Sets" 4<sup>th</sup> Commercial Vehicle Technology Symposium (CVT 2016), Kaiserslautern, Germany, March 8-10, 2016.

- 
- [103] Samuelsson, T., “Automatic Selection of Representative Operating Cycle in Large Measurements”, student summer work, Volvo internal report, 2014.

